

TILLIG **TT** BAHN



# TT-Katalog

2014/2015

### Dear model railway enthusiasts,

In the meantime the TT-catalog by TILLIG Modellbahnen GmbH comprises more than 240 pages introducing the full range of products. It goes without saying that the catalog not only includes all the new products that were launched at the beginning of the year, but also the autumn highlights, which are going to be presented at the end of August. All in all, the TT-catalog holds everything making the hearts of model railroad enthusiasts leap for joy. Whether you're interested in "wheeled" items, steam engines and cars resp. wagons, or various track systems along with track beds, digital components, a multitude of starter kits, and, and, and... Further enhancements were made to the product line of road vehicles, which are indispensable when it comes to the configuration of a railroad system. Meanwhile, the offer includes more than 25 different products. Things are moving forward with respect to the scale of 1:120. Discover the exciting news in the TILLIG-TT-catalog!

Latest novelties enhance the product line; let's throw a glance at some of our highlights:

In addition to the Rheingold set coming up with a newly designed E10 plus dome car, another set including a buffet car and railroad car is already available since the beginning of the year. As a result of the entire new construction of the double wagon consisting of pocket and container wagons, the goods wagons are complemented by another interesting model. Also worth mentioning is an additional variant of the bogie goods wagon of the type Eaos, whose wagon construction has been improved. TT-customers frequently asked for an expansion of the passenger car / truck range. This is supposed to take place with our first models of the truck Robur. Plans are to produce the truck in two versions, thus as a single model and in various designs for the loading onto goods wagons.

Dear TT-friends, we'd like to wish you lots of fun with our new catalog and would be very pleased to keep on inspiring you as a TT-model railroader. ■

*Your TILLIG Model Railway team*

### Liebe Modellbahnfreunde,

der neue TT-Katalog der TILLIG Modellbahnen GmbH umfasst mittlerweile mehr als 240 Seiten, auf denen sich das gesamte Sortiment widerspiegelt. Darin enthalten sind natürlich alle Neuheiten, die zum Jahresanfang 2014 veröffentlicht wurden, als auch die Herbstneuheiten, die per Ende August 2014 hinzugekommen sind. Somit ist hier alles zu finden, was das Modellbahnhobby in der Nenngröße TT interessant macht. Egal ob es sich um das „rollende“ Material handelt, also Loks und Wagen, oder unterschiedliche Gleissysteme, dazu Gleisbettungen, Digitalkomponenten, diverse Startsets und und und... Auch das Sortiment der Straßenfahrzeuge, unverzichtbar bei der Ausgestaltung einer Modellbahnanlage, hat sich weiter entwickelt und beinhaltet nunmehr über 25 unterschiedliche Artikel. Es tut sich etwas im Maßstab 1:120. Im neuen TILLIG-TT-Katalog können Sie es erleben!

Aktuelle Neuheiten bereichern das Sortiment; hier ein kurzer Auszug einiger Highlights:

Zur Ergänzung des Rheingold-Sets, mit formneuer E10 und Aussichtswagen, ist bereits seit Jahresanfang ein weiteres Set mit Buckelspeisewagen und Reisezugwagen erhältlich. Die Güterwagen werden durch die komplette Neukonstruktion des Doppeltraggwagens, bestehend aus Taschen- und Containerwagen, mit einem weiteren interessanten Modell ergänzt. Nicht zu vergessen ist eine zusätzliche Variante der vierachsigen Güterwagen Bauart Eaos, jetzt mit geändertem Wagenaufbau. Ein vielfach geäußelter Wunsch der TT-Kunden war der Ausbau des PKW/LKW-Sortimentes. Dies erfolgt in diesem Jahr mit den ersten Varianten des LKW Robur. Dieser ist einerseits als Einzelmodell, andererseits auch als Beladung auf Güterwagen in verschiedenen Ausführungen geplant.

Verehrte TT-Freunde, wir wünschen Ihnen viel Spaß mit unserem neuen Katalog und freuen uns, Sie auch weiterhin als TT-Modellbahner begeistern zu dürfen. ■

*Ihr Team von TILLIG-Modellbahnen*





4	Allgemeine Informationen/General informations
16	Länderbahnen der Epoche I State Railways of the German Empire (period I)
18	Deutsche Reichsbahn Gesellschaft Epoche II State Railways of the DRG (period II)
25	Deutsche Reichsbahn/German State Railway • Epoche III – Seite (page) 25 • Epoche IV/V – Seite (page) 45 •
71	Deutsche Bundesbahn/German Federal Railways • Epoche III – Seite (page) 71 • Epoche IV – Seite (page) 84 •
96	Deutsche Bahn AG/German Railway • Epoche V/VI – Seite (page) 96 •
119	Privatbahnen Deutschland Epoche V/VI Private Railways in Germany period V/VI
129	Ausländische Bahnverwaltungen/Foreign Railways
174	START-Programm/Models for Beginners
176	Einsteiger-Sets/Starter sets
186	TT-Digital/TT-Digital
192	TT-Bettungsgleis/TT-Bedding-Track-System
200	TT-Modellgleis/TT-Advanced-Track-System
216	STYROSTONE®-Gleisbettung/-Track-Bedding
222	Zubehör & Ersatzteile/Accessories & spare parts
231	TILLIG-Straßenbahn-Gleissystem/TILLIG-Tram track system
232	Händlerverzeichnis Ausland List of importeurs and dealers in foreign country
233	Index und Impressum

Bahngesellschaften und Epochen/Railway companies and epoch

K.P.E.V. ....	Königlich Preußische Eisenbahn-Verwaltung	SZD .....	Eisenbahnen der UdSSR (bis 1992)
K.Sächs.St.E.B.	Königlich Sächsische Staatseisenbahn	RZD .....	Russische Eisenbahnen (ab 1992)
DRG .....	Deutsche Reichsbahn Gesellschaft (1920 – 1945)	SJ .....	Schwedische Staatsbahnen
DR .....	Deutsche Reichsbahn (1945 – 1993)	PKP .....	Polnische Staatsbahn
DB .....	Deutsche Bundesbahn (1949 – 1993)	GySEV .....	Győr-Sopron-Ebenfurti Vasút
DB AG .....	Deutsche Bahn Aktiengesellschaft (ab 1994)	MAV .....	Ungarische Staatsbahnen
ČSD .....	Tschechoslowakische Staatsbahn (bis 1992)	SBB/CFF/FFS .....	Schweizerische Bundesbahnen
ČD .....	Tschechische Bahnen (ab 1993)	ÖBB .....	Österreichische Bundesbahnen
SNCF .....	Französische Eisenbahngesellschaft	DSB .....	Dänische Staatsbahnen
SNCB .....	Belgische Eisenbahngesellschaft	CFR .....	Rumänische Eisenbahngesellschaft
FS .....	Italienische Eisenbahngesellschaft	ŽSR/ZSSK .....	Slowakische Bahnen

Hinweis zu Zugbildungen

Note concerning the train formations



Im Interzonenzugverkehr (BRD – DDR) eingesetzte Reisezugwagen

Railway carriages used in interzone transport (West Germany – German Democratic Republic)



International verkehrende Reisezugwagen

Railway carriages that operate internationally

Einsatzmöglichkeiten von Triebfahrzeugen

Application options for tractive units



Typische Lokeinsätze

Typical use as locomotives













Weiterhin möglicher Einsatz









In addition possible use as

Bei Güterwagen ist ein grenzüberschreitender Wageneinsatz üblich, so dass Ihnen dadurch fast unbegrenzte Möglichkeiten der Zugbildung zur Verfügung stehen. / In the case of freight carriages the cross-border use of wagons is very frequently applied so you have almost unlimited train formation options.

Epoche I Länderbahn-Epoche	Epoche II Reichsbahn-Epoche	Epoche III Frühe Bundesbahn (D)- und Reichsbahn (DDR)-Epoche
Von 1835 bis zur Gründung der Deutschen Reichsbahn (1920) From 1835 till the foundation of the German State Railway (1920)	Von Gründung der Deutschen Reichsbahn bis Ende des II. Weltkrieges (1920 – 1945) From the foundation of the German State Railway till the end of the 2nd World War (1920 – 1945)	Vom Ende des II. Weltkrieges bis etwa 1970 From the end of the 2nd World War till 1970
Epoche IV Späte Bundesbahn (D)- und Reichsbahn (DDR)-Epoche	Epoche V Epoche der Deutschen Bahn AG	Epoche VI Epoche des liberalisierten Schienenverkehrs
Etwa ab 1968/70 bis 1990 About 1968/70 till 1990	Fahrzeuge in Farbgebung ab 1990 – 2007 Railways in colouring of 1990 till 2007	Ab 2007 Since 2007

Technische Daten/Technical informations

-  Epochenbezeichnung nach NEM 806 D  
Epoch according to NEM 806 D
-  Länge über Puffer in mm  
Length from buffer to buffer
-  2-Licht-Spitzensignal mit Fahrrichtung wechselnd  
2-front-light, dependet on the direction of traffic
-  2-Licht-Spitzensignal /2 Schlussleuchten, fahrtrichtungsabhängig  
2-front-light/2 rear light, dependet on the direction of traffic
-  3-Licht-Spitzensignal /2 Schlussleuchten, fahrtrichtungsabhängig  
3-front-light/2 rear light, dependet on the direction of traffic
-  3-Licht-Spitzensignal an beiden Fahrzeugenden, fahrtrichtungsabhängig / 3-front-light on both sides of the car, dependet on the direction of traffic
-  3-Licht-Spitzensignal vorn/2-Licht-Spitzensignal hinten, fahrtrichtungsabhängig / 3-front-light on the frontside/2-front-light on the backside, dependet on the direction of traffic
-  Mit Inneneinrichtung ausgestattet  
Equipped with interior decoration
-  Mit Innenbeleuchtung ausgestattet  
Equipped with interior lighting
-  Innenbeleuchtung nachrüstbar  
Interior lighting possible to refit
-  Bei Digitalbetrieb Glühlampen auf mind. 10V wechseln (Art. 08879)/Replace all bulbs with at least 10V-type bulbs before using these model cars on a digital run layout (product no. 08879)

-  Oberleitungsbetrieb möglich  
Switchable to use catenary
-  Rmin 310  
Befahrbarer Mindestradius  
Minimum radius
-  Kupplungsaufnahme und Kurzkupplungskinematik nach NEM 358 / Coupling pick-up and close coupling kinematics agree with NEM 358
-  Kupplungsaufnahme nach NEM 358 ohne Kurzkupplungskinematik / Coupling pick-up agree with NEM 358 without close coupling kinematics
-  Hauseigene Kupplungsaufnahme  
Own Coupling pick-up
-  Elektrische Schnittstelle nach NEM 651, mit Steckvorrichtung/Electrical interface agree with NEM 651, with plug
-  Elektrische Schnittstelle nach NEM 651, ohne Steckvorrichtung / Electrical interface agree with NEM 651, without plug
-  12-polige Digitalchnittstelle PluX12 (NEM 658)  
12 pole digital interface PluX12 (NEM 658)
-  18-polige Digitalchnittstelle nach NEM 662  
18 pole digital interface agree with NEM 662

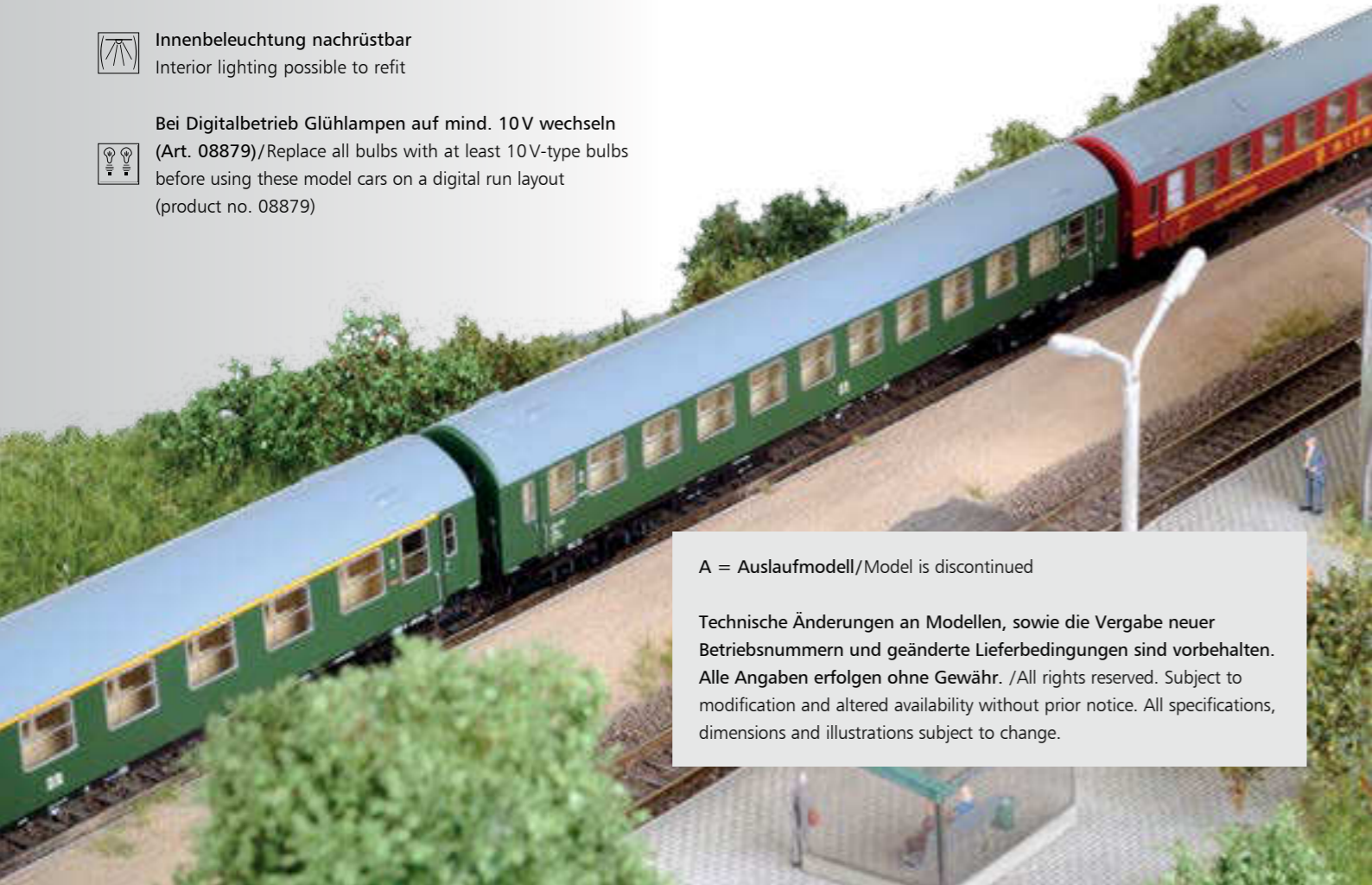

A = Auslaufmodell/Model is discontinued

Technische Änderungen an Modellen, sowie die Vergabe neuer Betriebsnummern und geänderte Lieferbedingungen sind vorbehalten. Alle Angaben erfolgen ohne Gewähr. /All rights reserved. Subject to modification and altered availability without prior notice. All specifications, dimensions and illustrations subject to change.

Herzlich willkommen!

Sebnitz ist bekannt als der Firmensitz des weltweit größten Herstellers der bekannten TT-Modellbahn: TILLIG Modellbahnen GmbH. Entdecken Sie hier in unserem Museum die über 100-jährige Geschichte der Modellbahn. Betrachten Sie dazu eine umfangreiche Anzahl von Dokumenten, Fotos, Schaustücken und Modellbahnanlagen. Weiterhin präsentieren wir Ihnen in unserem Museum zahlreiche Handmuster oder aktuelle Arbeitsstände aktueller Formneuheiten, die noch nicht im Handel verfügbar sind.

In der zweiten Etage bieten wir unseren Besuchern u.a. auch wechselnde Sonderausstellungen zu verschiedenen Themen an. Seit der Neueröffnung im Mai 2011 konnten Sie bereits zusätzliche Ausstellungen zu folgenden Themen besuchen:

- „TT in Tschechien“ (November 2011 bis März 2013)
- „Die Geschichte von Auhagen“ (April 2013 bis März 2014)
- „Gleissortimente der Firma TILLIG“ (seit April 2014)

Unser Schulungs- und Seminarraum bietet Ihnen die Möglichkeit, an unterschiedlichsten Workshops teilzunehmen, die sich rund um das Thema „Modellbahn“ drehen (weitere Informationen dazu auf [www.tillig.com](http://www.tillig.com)). In unserer Modellbahn-Galerie können Sie nach Herzenslust in dem aktuellen TILLIG-TT-/HO- und Schmalspursortiment stöbern. Auch unser Kundendienst bietet Ihnen einen erstklassigen Service vor Ort.

Viele Gründe, die für einen Besuch in unserer TILLIG Modellbahn-Galerie sprechen. Informationen über unsere aktuellen Ausstellungsthemen sowie die Öffnungszeiten der TILLIG Modellbahn-Galerie finden Sie im Internet unter [www.tillig.com](http://www.tillig.com).

Besuchen Sie uns, wir freuen uns darauf, Sie in Sebnitz begrüßen zu dürfen!

Welcome!

We kindly welcome you to our museum in the TILLIG Model Railroad Gallery. Sebnitz is the official headquarters of the world's most renowned manufacturer of the famous TT-model railroad: TILLIG Modellbahnen GmbH.



Our museum provides you deep insights into the 100-year old history of the model railroad. Discover our large collection of documents, pictures, show pieces, and model railroad systems. Besides, our museum holds a collection of numerous hand-made samples or the current progress of our latest designs and shapes, which haven't been launched, yet.

On the second floor, we organize special themed exhibitions for our visitors every once in a while. Since the reopening in May 2011, we have organized the following special themed exhibitions:

- "TT in Czechia" (November 2011 until March 2013)
- "The history of Auhagen" (April 2013 until March 2014)
- "Track assortments manufactured by TILLIG" (since April 2014)

Our training and seminar rooms provide our visitors with the opportunity to participate in a variety of workshops dealing with the subject "Model railroad" (please visit [www.tillig.com](http://www.tillig.com) for more information). Our model railroad gallery invites you to discover our most recent TILLIG-TT-/HO- and narrow-gauge product range. Needless to say, that our competent customer support team is always at your service.

There are plenty of reasons to drop by for a visit at our TILLIG Model Railroad Gallery. More details and information about our current exhibition themes, as well as the opening hours of the TILLIG Railroad Gallery can be found online: [www.tillig.com](http://www.tillig.com).

Come and join us, we look forward to your visit to Sebnitz!



Qualität und Präzision in allen Bereichen ...

Präzision, Detailgenauigkeit und Zuverlässigkeit: Dies zeichnet unsere Produkte aus. Um dieses Ziel zu erreichen, stellen wir uns selbst natürlich höchste Ansprüche in all unseren Fertigungsschritten.

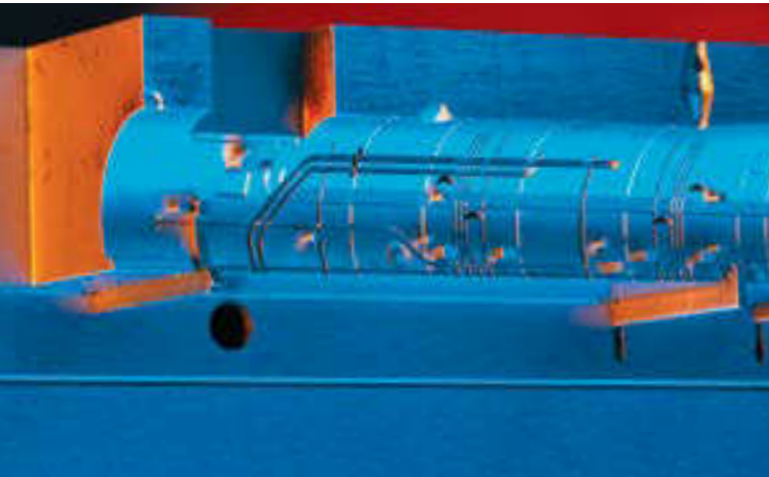
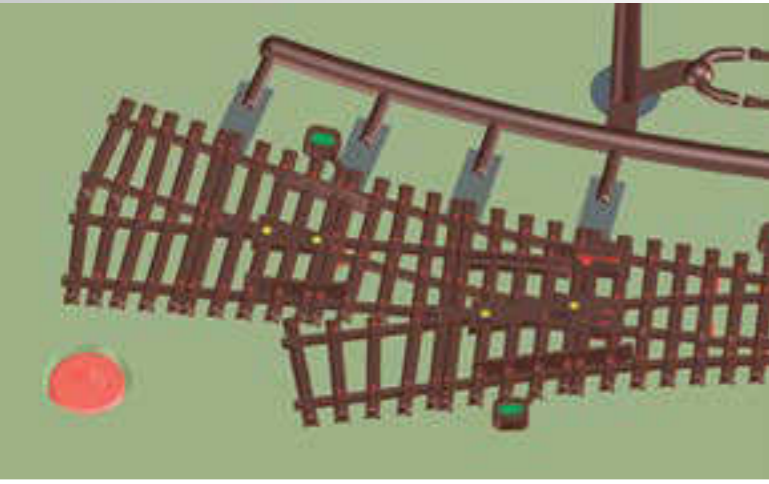

**Konstruktion:**

Jahrelange Erfahrung unserer Konstrukteure, moderne CAD-Systeme und die ständige Suche nach Innovationen: hier wird der „Grundstein“ für ein erfolgreiches TILLIG-Modell gelegt. In der Konstruktion entstehen alle TILLIG-Modelle.

**Design:**

Many years of experience of our designers, modern CAD systems and a constant search for innovations: The „foundation stone“ for a successful TILLIG model is laid here. All TILLIG models emerge in the construction.

**Werkzeugbau:**

Hohe Detailtreue, feinste Gravuren an den Modellen, Toleranzen im Hundertstel-Millimeter-Bereich ... Dafür steht unseren Spezialisten im Werkzeugbau modernste Technik zur Verfügung.

**Tool construction:**

High attention to detail, the finest engravings on the models, tolerances down to a hundredth of millimetre ... State of the art technology is available to our specialists in the tool construction sector to this end.

**Kunststoffspritzerei:**

Automatische Spritzgießmaschinen gewährleisten einen hochproduktiven Ausstoß an Spritzteilen. Die optimale Einstellung und ständige Überwachung der Spritzparameter (Temperatur, Druck, Abkühlzeit usw.) ist unerlässlich für die hochwertige Qualität der Kunststoffteile.

**Plastic injection moulding plant:**

Automated injection moulding machines guarantee a highly productive output of injection moulded parts. The ideal settings and constant monitoring of the injection moulding parameters (temperature, pressure, the cooling period etc) is imperative to ensure the quality of the plastic parts.

Quality and precision in all regions ...

Precision, attention to detail and reliability. These are the outstanding features of our products. We do of course subject our work to the highest demands in all our manufacturing steps to achieve this goal.

**Druckvorstufe:**

Nach genauester Recherche der Dekoration des Originals erfolgt am PC die Erstellung der Vorlagen für Lackierung und Bedruckung.

**Pre-press:**

The templates for the lacquering and printing on the PC are produced following the most precise research of the decoration of the original.

**Lackiererei und Druckerei:**

Die Lackierung der Modelle erfolgt mit der Hand-Spritzpistole. Große Erfahrung für einen gleichmäßigen Farbauftrag ist hier Voraussetzung. Eine gestochen scharfe Bedruckung unserer Modelle wird durch das Tampondruck-Verfahren ermöglicht, oft sind kleinste Anschriften nur noch unter der Lupe lesbar.

**Paintshop and printing shop:**

The models are painted with a hand spray gun. Great experience is essential here to ensure the paint is applied evenly. High definition printing of our models is made possible by pad printing, often smallest inscriptions can only be read under a loupe.

**Endmontage:**

Sowohl der Gleisbau als auch die Montage von Modellen erfolgen fast ausschließlich in Handarbeit. Geduld und Fingerfertigkeit sind hier gefragt. Dies meistern unsere Mitarbeiter der Montage stets mit viel Liebe zum Detail.

**Final assembly:**

Both the construction of the structure and the assembly of the models is performed almost exclusively by hand. Patience and dexterity are called for here. Our assembly employees always master this with a great deal of painstaking attention to detail.

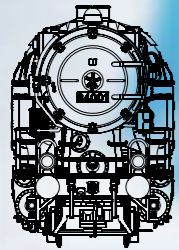

Nenngröße N  
Maßstab 1:160  
Spurweite 9 mm

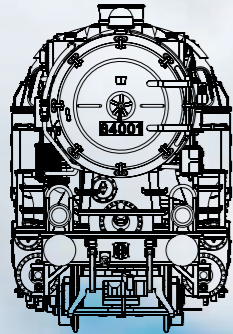

**Die Goldene Mitte**

Nenngröße TT  
Maßstab 1:120  
Spurweite 12 mm

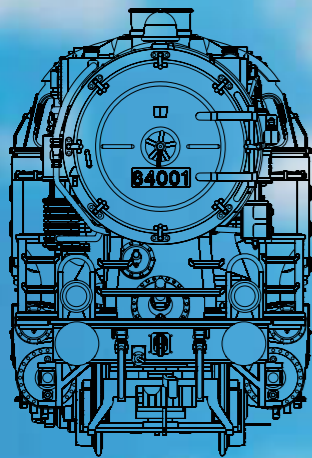

Nenngröße H0  
Maßstab 1:87  
Spurweite 16,5 mm

**Die Entstehung von TT / The origin of TT**

- 1945** Gründung der Firma „H. P. Products“ (Indiana, USA), Herstellung erster Modelle im Maßstab 1:120, Entstehung der Bezeichnung TT: „table top“  
Foundation of „H.P.Products“ (Indiana, USA) manufacturing of first models on the scale of 1:120 the name „TT“ (table top) comes into being
- 1948** Firma „Rokal“ auf dem (west)deutschen Markt, erstes TT-Set, führender TT-Bahn-Hersteller bis in die 60er Jahre  
„Rokal“ presents the first TT-set at the West German market and is leading TT manufacturer until the sixties
- 1957** Firma „Zeuke & Wegwerth KG“ in (Ost)Berlin Etablierung und Ausbau eines neuen TT-Sortimentes  
„Zeuke & Wegwerth KG“ establishes in East Berlin and develops a new TT assortment
- 1972** Verstaatlichung der „Zeuke & Wegwerth KG“ zu „VEB Berliner TT Bahnen“ (BTTB) Verbreitung der Spurweite TT – zeitweise fünftgrößter Modellbahnhersteller in ganz Europa  
„Zeuke & Wegwerth KG“ is nationalized to „VEB Berliner TT Bahnen“ (BTTB) extension of the track TT – occasionally the fifth biggest model railway manufacturer in Europe
- 1990** Reprivatisierung von BTTB zu „Berliner TT Bahnen Zeuke GmbH“ Denationalisation of BTTB to „Berliner TT Bahnen Zeuke GmbH“
- 1993** Fortsetzung der Tradition der TT-Bahn-Herstellung durch TILLIG nach Übernahme der TT-Produktion, neuer Standort: Sebnitz  
TILLIG assumes TT production and continues the tradition of TT railway production, new location is Sebnitz
- Ab 1993** Umfangreiche Überarbeitungen der früheren BTTB-Modelle, zahlreiche TILLIG-Neukonstruktionen im Rollmaterial und Zubehör  
Since 1993 happens an extensive revision of the former BTTB models, numerous new constructions of rolling stock
- 1994** Erster TILLIG-Katalog/First TT-catalog
- 1996** Weltgrößter Hersteller von TT-Modelleisenbahnen mit einem kompletten Sortiment im Maßstab 1:120  
World's largest manufacturer of TT model railways with a complete range at the scale 1:120
- 2006** Einführung neue TILLIG-TT-Kupplung  
Introduction of the new TILLIG TT-coupling
- 2008** Jubiläum „15 Jahre TILLIG“/Jubilee „15 years TILLIG“
- 2010** Eröffnung Modellbahn-Galerie/Opening Modellbahn-Galerie

Bis heute sind von TILLIG über 50 Triebfahrzeuge und über 70 Wagen (Formneueheiten, Formvarianten, Überarbeitungen) erschienen, Deko-varianten nicht mit gezählt. / Until today more than 50 locomotives and 70 cars appeared by TILLIG, deco-variants not counted.



*Modelle mit Präzision*



*Stets gute Fahrt mit TT!*

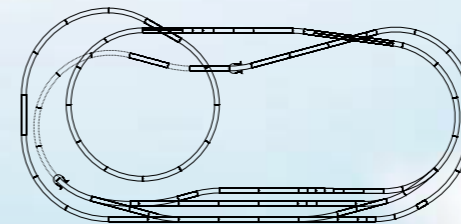

Beispielgleisplan für TT  
mit einer Grundfläche von 1,95 m x 0,95 m

**Größenverhältnisse der Spurweite TT**

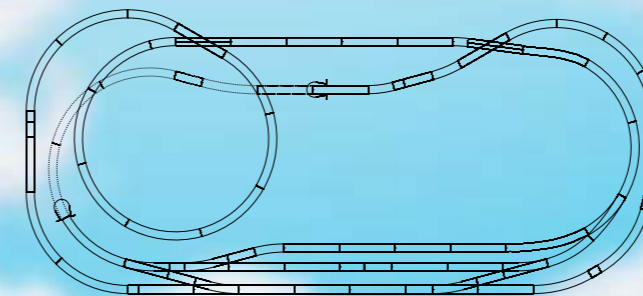

Der gleiche Gleisplan in H0  
benötigt eine Grundfläche von ca. 2,65 m x 1,30 m

**Vorzüge der Nenngröße TT**

*„Optimale Kombination von minimalem Raumbedarf, maximaler Modelltreue und Funktionssicherheit ...“*

Werner Zeuke,  
Firmen-Gründer von Zeuke & Wegwerth

- Eine TT-Modellbahn benötigt nur ca. 60% des Platzbedarfes einer vergleichbaren H0-Anlage, bietet dennoch gut handhabbare und vorbildgerechte Modelle, die sich in Detaillierung und Fahrverhalten ohne Einschränkung an H0-Großserienmodellen messen lassen.
- Durch den idealen Maßstab von 1:120 ergeben sich weit weniger platzbedingte Kompromisse gegenüber H0, wo Platzmangel nicht selten zum Einsatz verkürzter Längenmaßstäbe bei Wagen, zum Bau enger Radien oder relativ kurzer Bahnsteige zwingt.
- Gegenüber der Nenngröße N lassen sich wiederum kleine Details, auch im Anlagenbau selbst, bedeutend besser umsetzen.

**Amenity of the nominal size TT**

*„Ideal combination of minimum space requirements, maximum faithfulness of the model to the prototype and functional reliability...“*

Werner Zeuke,  
Company's founder of Zeuke & Wegwerth

- A TT scale model railway only requires approx. 60% of the space of a comparable H0 set-up. Still offers models that can be handled easily and are realistic, which certainly compare well to H0 large series models without any limitations in terms of their levels of detail and driving behaviour.
- Due to the ideal 1:120 scale far fewer space-related compromises are called for compared to the H0 scale where a lack of space does not infrequently lead to the use of reduced linear scales for the carriages, the construction of tighter radiuses or relatively short platforms.
- On the other hand small details even in the construction of the set itself can be realised much more favourably than in the case of the N nominal scale.

TILLIG-TT-Club

Im Jahr 1997 wurde der TILLIG-TT-Club gegründet. Nach nunmehr 17 Jahren des Bestehens haben sich über 4.300 TT-Kunden aus dem In- und Ausland im TT-Club angemeldet. Und die Anzahl der Club-Mitglieder steigt weiter. Hier erwarten Sie eine Vielzahl von Anregungen, Tipps und Tricks, aktuelle Informationen rund um das TT-Hobby und direkt aus dem Werk der TILLIG-Modellbahnen. Im Laufe eines Jahres erhalten Sie direkt an Ihre Adresse insgesamt vier Aussendungen zugeschickt. Diese enthalten die jeweils aktuellen Ausgaben unseres Club-Magazines „Club aktuell“, alle neu erschienenen Prospekte, Gutscheine für den Jahreskatalog TT usw. Doch auch der persönliche Kontakt ist uns sehr wichtig. So veranstalten wir jährlich unser Club-Treffen. Hier können Sie mit unseren Mitarbeitern fachsimpeln, Anregungen und Kritik anbringen oder einfach nur das Zusammensein mit TT-Bahnern genießen.

Hier noch mal unsere Club-Leistungen:

- Vier Ausgaben des Club-Magazines „Club aktuell“ pro Jahr
- Gutschein für einen kostenlosen TT-Jahreskatalog, einzulösen bei einem Händler Ihrer Wahl
- Persönliche Clubkarte
- Zusätzliche Publikationen und Prospekte
- Aktuelle Club-Newsletter an Ihre persönliche E-Mail-Adresse
- Kostenloser Eintritt in die Modellbahn-Galerie mit Museum (siehe S. 7)
- Ermäßigte Eintritte auf Messen usw. (wird jeweils bekanntgegeben)
- Jährliches Club-Treffen mit Möglichkeit zur Teilnahme an einem Workshop
- Exklusive Club-Modelle
- Exklusiver Mitgliederbereich auf der TILLIG-Homepage
- Preisnachlass bei Ersatzteilen
- Persönliche Betreuung für alle Fragen rund um das TT-Hobby über unsere Club- und Kundendienst-Hotline
- Kostenloser TT-Club-Jahreswagen



Viele interessierte Besucher kamen auch 2014 wieder zum „Tag der offenen Tür“ mit TILLIG-TT-Club-Treffen nach Sebnitz.



501503 - FORMNEUHEIT / NEW

Rekowagen 2. Klasse der DR, Epoche IV, Prototyp mit Übersetzfenstern

2nd class passenger coach of the DR, ep. IV, prototype with sliding windows



Exklusiv für Club-Mitglieder  
exclusive for TT Club members

501500 - FORMNEUHEIT / NEW  
Jahresmodell 2015

Offener Güterwagen Om Ludwigshafen der DRG, Epoche II

Modell of the year 2015

Open car Om Ludwigshafen of the DRG, Ep. II



Exklusiv für Club-Mitglieder  
exclusive for TT Club members

Mit unseren Club-Magazinen erhalten Sie viel Wissenswertes zum Thema Modellbahn, im Besonderen alles rund um die Spurweite TT wie z. B.: / You discover a lot of things worth knowing on the theme of the model railways with our club magazines, in particular everything about the TT track gauge such as:

- |   |  |
|---|--|
| <ul style="list-style-type: none"> <li>• Neuheitenvorstellungen</li> <li>• Interna aus dem TT-Werk</li> <li>• Informationen zu Veranstaltungen und Ausflugstipps</li> <li>• Extra Berichte über Sonder- und Exklusivmodelle</li> <li>• Überblick über Auslaufartikel</li> <li>• Vorbild- und Modellvorstellungen</li> <li>• Technik bei der Modellbahn</li> <li>• Anlagen- und Modulbau</li> <li>• Landschaftsbau neben dem Gleis</li> <li>• Zugbildungen</li> <li>• Aktuelle Informationen, wie z. B. Liefertermine</li> </ul> | <ul style="list-style-type: none"> <li>• Presentation of novel features</li> <li>• Internal information from the TT plant</li> <li>• Information on events and excursion tips</li> <li>• Extra reports on special and exclusive models</li> <li>• Overview of the discontinued lines</li> <li>• Presentations of prototypes and models</li> <li>• Model railway technology</li> <li>• Set and module construction</li> <li>• Landscape construction next to the track</li> <li>• Train formations</li> <li>• Current information such as delivery dates</li> </ul> |
|---|--|

Wir freuen uns, wenn auch Sie sich für eine Mitgliedschaft im TILLIG-TT-Club entscheiden und sich gleich anmelden. Entweder schriftlich mit unserem Anmeldeprospekt oder direkt auf unserer Homepage [www.tillig.com/](http://www.tillig.com/) / We would be delighted if you would also decide to become a member of the TILLIG-TT club and would register immediately. Either in writing using our registration brochure or directly on our homepage [www.tillig.com/](http://www.tillig.com/).

501390 ff. Workshop-Lok 2014

Elektrolokomotive 1216 der ÖBB, Ep. VI

Workshop locomotive 2014

Eledtric locomotive 1216 of the ÖBB epoch VI



Exklusiv für Club-Mitglieder  
exclusive for TT Club members

Exklusiv für Club-Mitglieder:  
Alle Club-Modelle aus den letzten Jahren können, so lange der Vorrat reicht, noch über den TILLIG-TT-Club bestellt werden.  
Exclusive for members of TT-Club:  
All club models of the last few years can be ordered at TILLIG-TT-Club as long as the stocks last.

TILLIG-TT-Club:  
Promenade 1, 01855 Sebnitz  
Fax: 035971/903-19  
E-Mail: [tt-club@tillig.com](mailto:tt-club@tillig.com)

Club-Hotline-Tel.:  
035971/53516  
(Dienstag 15.00 – 18.00 Uhr)

Kundendienst-Tel.:  
035971/903-45  
(Dienstag 13.00 – 18.00 Uhr  
Donnerstag 11.00 – 16.00 Uhr)

**Exklusiv für Club-Mitglieder**  
exclusive for TT Club members

**501490 ff.**  
**Workshop-Lok 2015**  
BR 220 043-4 der DB, Ep. IV  
**Workshop locomotive 2015**  
BR 220 043-4 of the DB, Ep. IV



**TILLIG-TT-Club**

Here is an overview of our club services once again:

- Four editions of the club magazin „Club aktuell“ respectively per year
- Voucher for a free TT annual catalogue that you can redeem at a retail trader of your choice
- Personal club card
- Additional publications and brochures
- Current club newsletter to your personal e-mail address
- Free entrance to the model railway gallery with the museum (see page 7)
- Reduced entrance at trade fairs (will be announced in each case)
- Annual club meeting with option of participating in a workshop
- Exclusive club models at special terms and conditions
- Spare parts at discount prices
- Personal support for questions relating to your TT-Hobby via our club and customer service hotline
- Free TT club annual car

The TILLIG-TT-club was founded in 1997. Now that it has existed for 17 years more than 4.300 TT customers have joined the TT club in Germany and abroad.

A large number of suggestions, tips and tricks, current information about all aspects of the TT hobby and directly from the TILLIG model railway factory await you here. You will have a total of four packages sent to your address in the course of a year. They contain the respective current editions of our club magazin „Club aktuell“, all the brochures that have just been published, gift vouchers for the annual catalogue TT etc. But personal contact is also very important for us. That is why we organise our club meetings annually. Here you can talk shop with our employees, bring up suggestions and criticisms or simply just enjoy spending time with TT model railway enthusiasts.

**501191 Workshop-Lok 2012**  
**Elektrolokomotive BR 701 (ex BR 155) der MEG, Ep. VI**  
**und Club-Exklusivmodell 2012 Art. 501197**  
**Workshop locomotive 2012**  
Electric locomotive class 701 of the MEG, epoch VI with Club exclusive model 2012 item-no. 501197

**Exklusiv für Club-Mitglieder**  
exclusive for TT Club members



Auf den unten aufgeführten Messen wird die Firma TILLIG Modellbahnen GmbH vertreten sein. Sie können sich auf den genannten Messen über unser TT-/H0-Gesamtsortiment und natürlich auch über den TT-Club informieren.  
TILLIG Modellbahnen will be represented at the following trade fairs.  
You can also inform yourself about our TT-/H0-products and the TT-Club there.

03. Okt. – 05. Okt. 2014	„Modell – Hobby – Spiel“ Leipzig
02. Okt. – 05. Okt. 2014	„Modell Hobby“ Prag/Tschechien
25. Okt. – 26. Okt. 2014	„Hobby“ Poznan/Polen
23. Okt. – 26. Okt. 2014	„Modellbaumesse“ Wien/Österreich
31. Okt. – 02. Nov. 2014	„Faszination Modellbau“ Friedrichshafen
20. Nov. - 23. Nov. 2014	„Internationale Modellbahn Ausstellung“ Köln
13. Feb. – 15. Feb. 2015	„10. Erlebnis Modellbahn“ Dresden
06. März – 08. März 2015	„Faszination Modellbahn“ Sinsheim
15. April – 19. April 2015	„Intermodellbau“ Dortmund
13. Juni 2015	„Tag der offenen Tür“ bei TILLIG Modellbahnen in Sebnitz





CAD-Zeichnung

NEU	155	loooo	Rmin	310	NEM	NEM602
Art.-Nr: 02022	UVP in €: 279,90					

**FORMNEUHEIT:** Dampflokomotive P8 der K.P.E.V.  
**NEW:** Steam locomotive class P8 of the K.P.E.V.

- Neue Loklaternen mit warm-weißer LED / new lamps with warm-white LED
- Kurzkupplungskinematik am Tender / close coupling kinematic at the tender
- Ursprungsausführung in Grün, ohne Windleitbleche und mit Gasbeleuchtung, ohne drittem Spitzenlicht / original version in green, without smoke deflectors and with gas lighting, without 3rd headlight
- Tenderbauart 2'2'T 21,5 / tender type 2'2'T 21,5



NEU	147	oooo	NEM	NEM	NEM
Art.-Nr: 02165	UVP in €: 209,90				

Dampflokomotive G 8.2 der K.P.E.V.  
 Steam locomotive class G 8.2 of the K.P.E.V



NEU	334	NEM	NEM
Art.-Nr: 01682	UVP in €: 94,90		

Reisezugwagenset der K.P.E.V., bestehend aus drei Abteilwagen  
 Passenger coach set of the K.P.E.V., with three different passenger coaches



NEU	110	NEM	NEM
Art.-Nr: 13149	UVP in €: 32,50		

Abteilwagen der K.P.E.V.  
 Passenger coach of the K.P.E.V.



Handmuster

NEU	110	NEM	NEM
Art.-Nr.: 13455	UVP in €: 27,50		

Packwagen (Pw3 pr-11) der K.P.E.V.  
 Baggage waggon (type Pw3 pr-11) of the K.P.E.V.



96	NEM	NEM
Art.-Nr: 14628	UVP in €: 17,50	

Rungenwagen Rm der K.P.E.V.  
 Stake car Rm of the K.P.E.V.



83	NEM	NEM
Art.-Nr: 14284	UVP in €: 20,50	

Offener Güterwagen Ommk(u)  
 der K.Sächs.Sts.E.B. / Open car  
 Ommk(u) of the K.Sächs.Sts.E.B.



Zugbildung: PmG (Personenzug mit Güterbeförderung): 02165 - 01682 - 14628



Dampflokomotive BR 23.0 der DRG  
Steam locomotive class 23.0 of the DRG

	191	oo	oo	oo	oo	oo	oo	oo	oo	oo
Art.-Nr:	02101	UVP in €: 249,90								



Elektr.lokomotive E 18 der DRG  
Electric locomotive class E 18 of the DRG

	142	oo	oo	oo	oo	oo	oo	oo	oo	oo
Art.-Nr:	02453	UVP in €: 169,90								



**FORMNEUHEIT:** Dampflokomotive BR 38.10 der DRG  
**NEW:** Steam locomotive class 38.10 of the DRG

CAD-Zeichnung

NEU	155	oo	oo	Rmin	oo	oo	oo	oo	oo	oo
				310						NEM 662
Art.-Nr:	02023	UVP in €: 279,90								



Personenwagen 3. Klasse (Ci-30) der DRG  
3rd class passenger coach (Ci-30) of the DRG

	116	oo	oo	oo	oo	oo	oo	oo	oo	oo
Art.-Nr:	13208	UVP in €: 24,90								



Dampflokomotive BR 50 der DRG  
Steam locomotive class 50 of the DRG

	191	oo	oo	Rmin	oo	oo	oo	oo	oo	oo
				310						NEM
Art.-Nr:	02094	UVP in €: 249,90								



Personenwagen 2. Klasse (Bi-29) der DRG  
2nd class passenger coach (Bi-29) of the DRG

	116	oo	oo	oo	oo	oo	oo	oo	oo	oo
Art.-Nr:	13005	UVP in €: 32,50								



Dampflokomotive BR 84 der DRG  
Steam locomotive class 84 of the DRG

	130	oo	oo	oo	oo	oo	oo	oo	oo	oo
Art.-Nr:	02191	UVP in €: 222,90								



Packwagen Pw3 pr-11 der DRG  
Baggage car Pw3 pr-11 of the DRG

NEU	110	oo	oo	oo	oo	oo	oo	oo	oo	oo
Art.-Nr:	13411	UVP in €: 27,50								



Postwagen Post4-b/15 der Deutschen Reichspost  
Mail car Post4-b/15 of the German „Reichspost“

- Dachausführung mit Oberlichtern/with rooflight

NEU	136	136	136
Art.-Nr: 13891	UVP in €: 46,50		



Packwagen Pw4i-32 der DRG  
Baggage car Pw4i-32 of the DRG

NEU	175	175	175
Art.-Nr: 13827	UVP in €: 39,50		

Handmuster



Reisezugwagen 1./2. Klasse AB4ü-39 der DRG  
1st/2nd class passenger coach of the DRG

NEU	177	177	177
Art.-Nr: 16923	UVP in €: 47,50		

Reisezugwagen set der DRG, bestehend aus zwei Schürzenwagen  
(1 x 2./3. Kl., 1 x 3. Kl.) und einem Postwagen Post4-b/15  
Passenger coach set of the DRG, with three different coaches  
(one 2nd/3rd class, one 3rd class and one mail car Post4-b/15)

NEU	494	494	494
Art.-Nr: 01617	UVP in €: 139,90		



Zugbildung: Schnellzug der DRG: 02101 - Set 01617 - 16923



Reisezugwagenset der DRG, bestehend aus einem Speisewagen und zwei Personenwagen (1 x 1./2./3. Klasse, 1 x 3. Klasse)  
 Passenger coach set of the DRG with one dining car and two different passenger coaches (1 x 1st/2nd/3rd class, 1 x 3rd class)  
 • passend zu Set Art. 01617 / apposite to set art. 01617

NEU	554	NEU	NEU
Art.-Nr: 01579 A   UVP in €: 146,90			



Set: 01579



Güterwagenset DRG, bestehend aus: einem Kesselwagen „Kriegsmarinewerft“, einem Niederbordwagen mit Plane, einem gedeckten Güterwagen G Kassel  
 Freight car set of the DRG, with three different freight cars

NEU	244	NEU	NEU
Art.-Nr: 01673   UVP in €: 65,50			



Kesselwagen der Deutsch-Amerikanischen Petroleum-Gesellschaft, eingestellt bei der DRG  
 Tank car „Deutsch-Amerikanische Petroleum-Gesellschaft“ of the DRG

NEU	76	NEU	NEU
Art.-Nr: 17302   UVP in €: 25,50			



Kesselwagen der Wirtschaftlichen Forschungsgesellschaft, eingestellt bei der DRG  
 Tank car „Wirtschaftliche Forschungsgesellschaft“ of the DRG

NEU	74	NEU	NEU
Art.-Nr: 95835   UVP in €: 29,50			



Schotterwagen der DRG  
 Hopper car of the DRG  
 • mit geänderter Betriebsnummer / with new car number

NEU	58	NEU	NEU
Art.-Nr: 501285   UVP in €: 25,50			



Offener Güterwagen  
 Om Breslau der DRG  
 Open box car  
 Om Breslau of the DRG

NEU	83	NEU	NEU
Art.-Nr: 14282   UVP in €: 20,50			



Gedeckter Güterwagen  
Gr Kassel der DRG  
Box car Gr Kassel of the DRG

NEU	83		
Art.-Nr:	14124 A		
UVP in €:	23,50		



Weintransportwagen „Dt. Weinkesselwg.-Gesellschaft“  
eingestellt bei der DRG  
Wine barrel car of the DRG

NEU	83		
Art.-Nr:	14126		
UVP in €:	23,50		

Handmuster



Dampflokomotive BR 01 der DR mit Jubiläumseblem „800 Jahre Messe Leipzig“  
Steam locomotive class 01 of the DR

NEU	199			Lok	Tender
Art.-Nr:	02135				
UVP in €:	213,90				

Handmuster



Säuretopfwagen „IG Farben-industrie“,  
eingestellt bei der DRG  
Acid pot car „IG Farbenindustrie“  
of the DRG

83			
Art.-Nr:	14446		
UVP in €:	22,50		



Rungenwagen R Stuttgart  
der DRG / Stake car R Stuttgart  
of the DRG

96			
Art.-Nr:	14658		
UVP in €:	17,50		



Dampflokomotive BR 01.5 der DR  
Steam locomotive class 01.5 of the DR

199				Lok	Tender
Art.-Nr:	02004				
UVP in €:	249,90				

Handmuster

- Mit Umlaufschürze und Boxpok-Treibradsätzen / with cover panel and Boxpok-Wheelsets



Schwerlastwagen SSyms Köln der DRG,  
beladen mit Holzkiste  
Flat car SSyms Köln of the DRG,  
loaded with a wooden box

110			
Art.-Nr:	15612 A		
UVP in €:	45,90		



Dampflokomotive BR 03.2 (Reko) der DR  
Steam locomotive class 03.2 (reconstructed) of the DR

199				Lok	Tender
Art.-Nr:	02145				
UVP in €:	249,90				

- Neue Lampen und Kessel mit freistehenden Kesselleitungen/new lamps and freestanding boiler pipes
- Kurzgekuppelte feste Lok-Tender-Verbindung/close coupled and fixed connection locomotive – tender



Kesselwagen „NITAG“,  
eingestellt bei der DRG  
Tank car „NITAG“ of the DRG

74			
Art.-Nr:	95832		
UVP in €:	29,50		

- Ausführung mit weißem Kessel und ursprünglichen Firmenfarben Grün/Gelb / with white tank and origin company colours green/yellow



Kesselwagen „J. Diebolt Nachf.“,  
eingestellt bei der DRG  
Tank car „J. Diebolt Nachf.“  
of the DRG

74			
Art.-Nr:	95828 A		
UVP in €:	28,50		

- Mit neuer Betriebsnummer erhältlich / with new car number



FORMNEUHEIT: Dampflokomotive BR 38.10 der DR  
NEW: Steam locomotive class 38.10 of the DR

NEU	166			Rmin	
Art.-Nr:	02020				
UVP in €:	279,90				

FORMNEUHEIT: Dampflokomotive BR 38.10 der DR - mit Sound  
NEW: Steam locomotive class 38.10 of the DR - with sound

NEU	166			Rmin	
Art.-Nr:	92653				
UVP in €:	429,90				

- Mit Witte-Windleitblechen, Giesl-Ejektor und Tender 2'2'T 31,5/ with Witte smoke deflectors, Giesl-ejector and tender type 2'2'T 31,5



Dampflokomotive BR 50.35-37 der DR  
Steam locomotive class 50.35-37 of the DR

	191		Rmin			
Art.-Nr: 02292 A	UVP in €: 249,90					



Dampflokomotive BR 56 der DR  
Steam locomotive class 56 of the DR

	147				
Art.-Nr: 02160	UVP in €: 209,90				

- Wieder im Sortiment mit neuen Lampen, überarbeitetes Fahrwerk / with new lamps and revised undercarriage



Dampflokomotive BR 86 der DR  
Steam locomotive class 86 of the DR

<b>NEU</b>		113				
Art.-Nr: 02179	UVP in €: 169,90					



Dampflokomotive BR 52 der DR  
Steam locomotive class 52 of the DR

- Altbau-Lok / with origin boiler
- Neue Lampen / with new lamps

	193		Rmin			
Art.-Nr: 02287	UVP in €: 249,90					



Dampflokomotive BR 84 der DR  
Steam locomotive class 84 of the DR

- Nachbildung des Vorbildes mit Dreizylinder-Fahrwerk / version with 3-cylinder undercarriage
- Neue Lampen und Kessel mit freistehenden Kesselleitungen / new lamps and freestanding boiler pipes

	130				
Art.-Nr: 02190 A	UVP in €: 222,90				



Foto: J. Stahl

Dampflokomotive BR 95 der DR  
Steam locomotive class 95 of the DR

<b>NEU</b>		130				
Art.-Nr: 03010	UVP in €: 239,00					

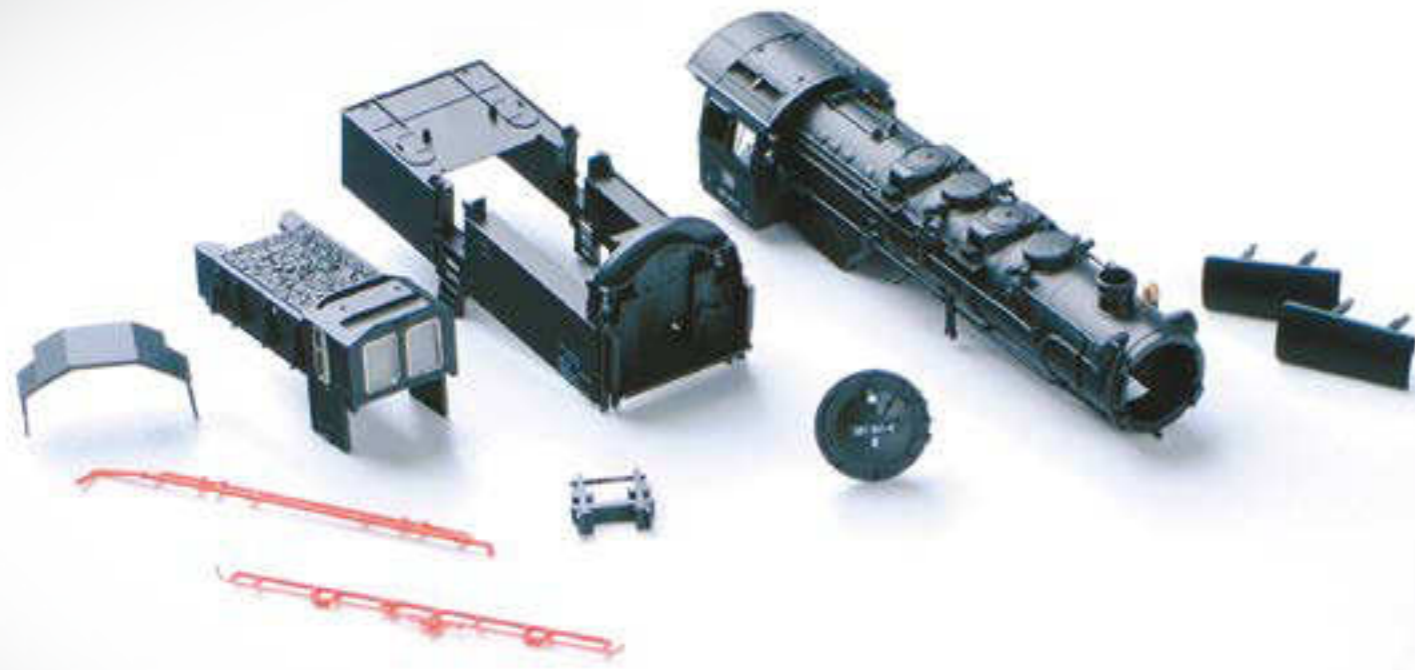

Technische Eigenschaften unserer Dampflok-Modelle:

- Schleptender-Loks mit Tenderantrieb (außer BR 56)
- Modelle neuerer Produktion sind mit warm-weißen LED ausgestattet
- 5-polige Motoren mit Schwungradmasse
- Fein detaillierte Steuerung aus Kunststoff
- Rahmen aus Zinkdruckguss
- Hochdetaillierte Kunststoffgehäuse mit freistehenden Kesselleitungen
- Weitere Details finden Sie in den Beschreibungen der einzelnen Modelle





Technical characteristics of our steam locomotive models:

- Locomotives with tender with tender drive (excluding BR 56)
- Models in current production are equipped with warm-white LED
- 5 pole motors with flywheel mass
- A very detailed valve gear rods made of plastic
- Frame made of die-cast zinc
- Extremely detailed plastic housing with freestanding boiler pipes
- You can find further details in the descriptions of the individual models









Triebwagen VT 137 mit Steuerwagen VS 145 der DR  
 Railcar class VT 137/VS 145 of the DR  
 • unveränderte Wiederauflage

NEU  365      
 Art.-Nr: 02850 UVP in €: 222,90





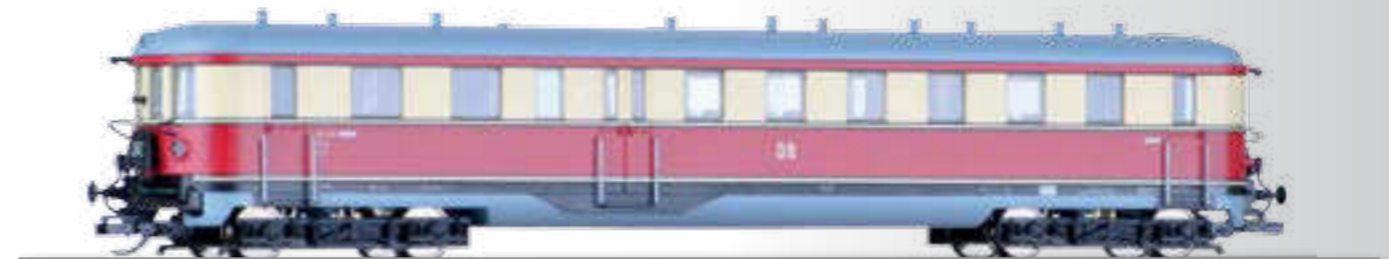

Diesellokomotive V 60.10-11 der DR / Diesel locomotive class V 60.10-11 of the DR

- Zusätzliche Lichteffekte bei Einsatz des Decoders 66017 / additional lighting effects at digital use (only with decoder 66017)

 91     
 Art.-Nr: 96112 UVP in €: 179,90







Steuerwagen VS 145 der DR  
 Driving cab coach VS 145 of the DR

NEU  169     
 Art.-Nr: 13301 UVP in €: 72,90







Diesellokomotive V 75 der DR  
 Diesel locomotive class V 75 of the DR

 105     
 Art.-Nr: 04623 A UVP in €: 169,90







Diesellokomotive V 180 der DR  
 Diesel locomotive class V 180 of the DR

 162     
 Art.-Nr: 02672 A UVP in €: 157,50



Diesellokomotive V 100 der DR  
 Diesel locomotive class V 100 of the DR

- Ursprungslackierung mit 2 Streifen / original colouring with two stripes
- Mit neuer Betriebsnummer erhältlich / with new car number

 116     
 Art.-Nr: 02582 UVP in €: 154,90



Elektr.lokomotive E 18 der DR  
 Electric locomotive class E 18 of the DR

 141     
 Art.-Nr: 02454 UVP in €: 169,90





Rangierdienst Shunting service	Personenzüge/ Nahverkehr Passenger trains/local train traffic	Eilzüge Express trains	D-Züge/ Fernverkehr Express trains/ long distance travel	Güterverkehr Carriage of goods
-----------------------------------	---	---------------------------	--	--------------------------------------



BR 01 | BR 01.5



BR 03.2



BR 35.10



BR 38.10



BR 50 | BR 50.35

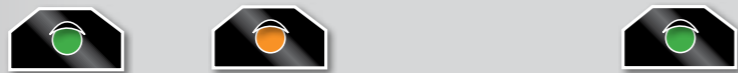

BR 52 | BR 52.80



BR 56

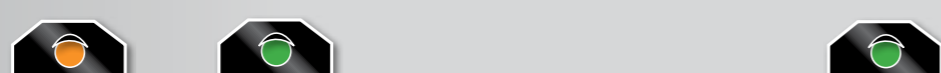

BR 86

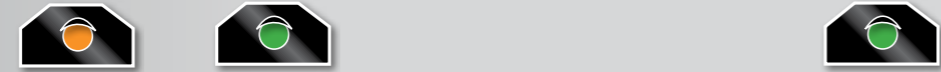

BR 84 | BR 95

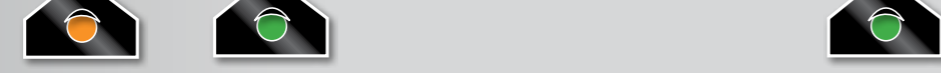

Rangierdienst Shunting service	Personenzüge/ Nahverkehr Passenger trains/local train traffic	Eilzüge Express trains	D-Züge/ Fernverkehr Express trains/ long distance travel	Güterverkehr Carriage of goods
-----------------------------------	---	---------------------------	--	--------------------------------------



V 36/BR 103 (\*)

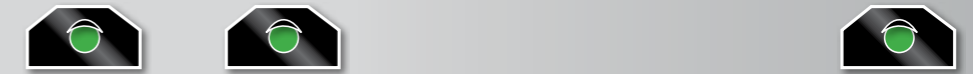

V 60/BR 106

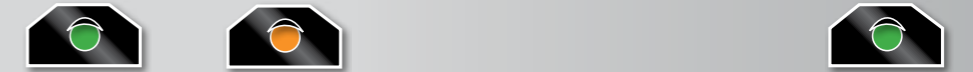

V 75/BR 107

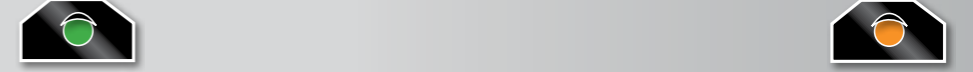

V 100/BR 110



V 180/BR 118 | BR 119



E 18/BR 218



E 11/BR 211



BR 243



BR 250



(\*) BR 103 in DR derzeit erhältlich als Sondermodell der Modellbahn-Galerie, Art. 501274 (Freelance-Ausführung in gelb)



Personenwagen 2. Klasse (ex Bi-29) der DR  
2nd class passenger coach (ex Bi-29) of the DR

	116		
Art.-Nr: 13001	UVP in €: 31,90		



Reisezugwagen 2. Klasse (ex C4i-30) der DR  
2nd class passenger coach (ex C4i-30) of the DR

	175				
Art.-Nr: 13311 A	UVP in €: 36,90				



Personenwagen 2. Klasse (ex BCi-29) der DR  
2nd class passenger coach (ex BCi-29) of the DR

	116		
Art.-Nr: 13010	UVP in €: 31,90		



Reisezugwagen 1./2. Klasse (ex BC4i-31) der DR  
1st/2nd class passenger coach (ex BC4i-31) of the DR

	175				
Art.-Nr: 13321 A	UVP in €: 36,90				



Packwagen (ex Pw3 pr-11) der DR  
Baggage car (ex Pw3 pr-11) of the DR

<b>NEU</b>		110		
Art.-Nr: 13412	UVP in €: 27,50			



Gepäckwagen (ex Pw4i-32) der DR  
Baggage car (ex Pw4i-32) of the DR

	175				
Art.-Nr: 13821 A	UVP in €: 39,50				

- Mit beweglichen Schiebetüren/with moveable sliding doors



Reisezugwagenset der DR, bestehend aus drei Rekowagen (3 x B4ge)  
Passenger coach set of the DR with three different passenger coaches (3 x B4ge)

		538				
Art.-Nr: 01620 A	UVP in €: 123,90					



Reisezugwagen 2. Klasse Bauart E5 der DR  
2nd class passenger coach type E5 of the DR

Handmuster

NEU			193			
Art.-Nr.: 13887	UVP in €: 40,90					



Speisewagen WR4ü-38 „MITROPA“ der DR  
Dining car WR4ü-38 „MITROPA“ of the DR

		196			
Art.-Nr.: 16970	UVP in €: 56,90				



Reisezugwagen 1. Klasse (ex BC4ü-38) der DR  
1st class passenger coach (ex BC4ü-38) of the DR

		177			
Art.-Nr.: 16900	UVP in €: 47,50				



Schlafwagen WLAB4ül-51 „MITROPA“ der DR  
Sleeping coach WLAB4ül-51 „MITROPA“ of the DR

		177			
Art.-Nr.: 16960	UVP in €: 52,50				



Reisezugwagen 1./2. Klasse (ex BC4ü-38) der DR  
1st/2nd class passenger coach (ex BC4ü-38) of the DR

		177			
Art.-Nr.: 16920	UVP in €: 47,50				



Postwagen Post-c/15 der Deutschen Post  
Mail wagon Post-c/15 of the „Deutsche Post“

		136			
Art.-Nr.: 13896 A	UVP in €: 47,50				



Reisezugwagen 2. Klasse (ex C4ü-38) der DR  
2nd class passenger coach (ex C4ü-38) of the DR

		177			
Art.-Nr.: 16940	UVP in €: 47,50				



Reisezugwagen 1. Klasse, Typ B, der DR  
1st class passenger coach, type B, of the DR

		204			
Art.-Nr.: 16301	UVP in €: 42,50				



Reisezugwagen 2. Klasse, Typ B, der DR  
2nd class passenger coach, type B, of the DR

			204		
Art.-Nr: 16341		UVP in €: 42,50			



Reisezugwagenset der DR, bestehend aus drei Reisezugwagen Typ B  
(1./2. Klasse, 2. Klasse, Speisewagen)  
Passenger coach set of the DR with three different passenger coaches type B  
(1st/2nd class, 2nd class, dining car)

			621		
Art.-Nr: 01600 A		UVP in €: 132,90			



Güterwagenset DR „Grundstoff-Industrie-Pendel 1“;  
bestehend aus drei verschiedenen offenen Güterwagen  
Freight car set of the DR with three different freight cars

NEU		239		
Art.-Nr: 01683		UVP in €: 66,90		





Schwerlastwagenset der DR, bestehend aus zwei Schwerlastwagen SSyms, beladen mit Panzer T34/85 der sowjetischen Armee

Flat car set of the DR with two flat cars SSyms loaded with tank type T34/85 of the Soviet Army

NEU	Handmuster	222	■	□	□	□
Art.-Nr.: 01675	UVP in €:	102,90				



Gedeckter Güterwagen Gr (ex Kassel) der DR  
Box car Gr (ex Kassel) of the DR

	Handmuster	83	■	□	□	□
Art.-Nr.: 14125 A	UVP in €:	23,50				



Offener Güterwagen Omu 36 der DR  
Open car Omu 36 of the DR

	Handmuster	83	■	□	□	□
Art.-Nr.: 14283	UVP in €:	20,50				



Güterwagenset DR „Grundstoff-Industrie-Pendel 2“; bestehend aus drei verschiedenen offenen Güterwagen  
Freight car set of the DR with three different freight cars

NEU	Handmuster	239	■	□	□	□
Art.-Nr.: 01684	UVP in €:	66,90				



Klappdeckelwagen Kmm 21 der DR  
Hinged cover car Kmm 21 of the DR

	Handmuster	76	■	□	□	□
Art.-Nr.: 14712	UVP in €:	23,50				



Niederbordwagen Xu der DR  
Low side car Xu of the DR

	III	76	■-□-□-□
Art.-Nr: 14920 A	NEM	→	NEM



Gedeckter Güterwagen (ex G Kassel) der DR  
Box car (ex G Kassel) of the DR

NEU	III	83	■-□-□-□
Art.-Nr: 17132	NEM	→	NEM



Schienenreinigungswagen der DR  
Rail cleaning car of the DR

- Ersatzschleifstück/  
bracket grinding stone: 390270

	III	91	■-□-□-□
Art.-Nr: 95291	NEM	→	NEM



Schotterwagen Otmu der DR  
Hopper car Otmu of the DR

NEU	III	58	■-□-□-□
Art.-Nr: 501273	NEM	→	NEM

- mit geänderter Betriebsnummer



Güterwagenset der DR, bestehend aus sechs verschiedenen Güterwagen (Niederbordwagen Xu, offener Güterwagen Omu, gedeckter Güterwagen Glxu, Kleinvieh-Verschlagwagen V, Säuretopfwagen Z, Klappdeckelwagen Kmm)



Schwerlastwagen der DR, beladen mit Flachbrammen  
Flat car of the DR loaded with slabs

	III	110	■-□-□-□
Art.-Nr: 15616 A	NEM	→	NEM

- Abnehmbare Rungen/changeable stakes



Güterwagenset „Militärtransport der NVA“ der DR, bestehend aus einem Mannschaftstransportwagen Mrs (ex. Oppeln) und zwei Schwerlastwagen SSyms beladen mit Panzer T 34/85

Freight car set „military transport“ of the DR with one box car Mrs (ex. Oppeln) and two flat cars SSyms loaded with two tanks type T 34/85

- Panzer mit drehbarem Turm und beweglicher Kanone /  
tank with turnable turret and moveable muzzle



	III	298	■-□-□-□
Art.-Nr: 01627	NEM	→	NEM

Freight car set of the DR with six different freight cars (low side car Xu, open car Omu, box car Glxu, partition car for animal transport V, acid pot car Z, hinged cover car Kmm)

	III	488	■-□-□-□
Art.-Nr: 01642	NEM	→	NEM



Kühlwagen Tnfs 17  
„Seefische“ der DR  
Refrigerator car Tnfs 17  
„Seefische“ of the DR

III	91	■	□	☐	☐
NEM	→	→	→	→	→
Art.-Nr: 14108 A		UVP in €: 25,50			



Eiskühlwagen TTnhhr der DR  
Refrigerator car TTnhhr  
of the DR

III	136	■	□	☐	☐
NEM	→	→	→	→	→
Art.-Nr: 15322 A		UVP in €: 34,50			



Güterwagenset der DR, bestehend aus drei Staubsilowagen Zkz  
Freight car set of the DR with three silo cars Zkz

- Komplette Neukonstruktion / new construction
- Mit neuen Betriebsnummern erhältlich / with new car numbers

III	214	■	□	☐	☐
NEM	→	→	→	→	→
Art.-Nr: 01607 A		UVP in €: 94,90			



Kesselwagen „VEB Teerverarbeitung Rositz“, eingestellt bei der DR  
Tank car „VEB Teerverarbeitung Rositz“ of the DR

III	74	■	□	☐	☐
NEM	→	→	→	→	→
Art.-Nr: 95833		UVP in €: 28,50			



Kesselwagen des VEB Sodawerk Bernburg, eingestellt bei der DR  
Tank car VEB Sodawerk Bernberg of the DR

NEU	III	74	■	□	☐	☐
	NEM	→	→	→	→	→
Art.-Nr: 95836		UVP in €: 28,50				



Güterwagenset der DR, bestehend aus drei Kalkkübelwagen  
Freight car set of the DR with three skip cars for transport of limestone

III	251	■	□	☐	☐
NEM	→	→	→	→	→
Art.-Nr: 01634 A		UVP in €: 85,90			



Reko-Sitz-/Gepäckwagen 2. Klasse der DR  
2nd class passenger coach with baggage compartment of the DR

- Ergänzung zu Set 01620 auf S. 34/35 / compatible with set 01620 on page 34/35

III	IV	155	■	□	☐	☐
NEM	NEM	→	→	→	→	→
Art.-Nr: 16600		UVP in €: 46,50				



Foto: D. Wünschmann

**FORMNEUHEIT:** Dampflok BR 38.10 der DR  
**NEW:** Steam locomotive class 38.10 of the DR

NEU	IV	155	oo	Rmin	■	□	☐	☐
	NEM	→	→	310	→	→	→	→
Art.-Nr: 02025		UVP in €: 279,90						



**FORMNEUHEIT:** Dampflok BR 35.10 der DR  
**NEW:** Steam locomotive class 35.10 of the DR

NEU	IV	oo	oo	■	□	☐	☐
	NEM	→	→	→	→	→	→
Art.-Nr: 02050		UVP in €: 249,90					

CAD-Zeichnung



Dampflokomotive BR 01 der DR  
Steam locomotive class 01 of the DR

Lok		Tender	
IV NEM	199	oo	oo
Art.-Nr: 02130	UVP in €: 213,90		

- Kurzgekuppelte feste Lok-Tender-Verbindung / close coupled and fixed connection locomotive – tender



Dampflokomotive BR 95 der DR  
Steam locomotive class 95 of the DR

Lok		Tender	
IV NEM	130	oo	oo
Art.-Nr: 03011	UVP in €: 239,00		

Foto: J. Stahl



Dampflokomotive BR 03 der DR  
Steam locomotive class 03 of the DR

Lok		Tender	
NEU	IV NEM	199	oo
Art.-Nr: 02146	UVP in €: 249,90		

- Kurzgekuppelte feste Lok-Tender-Verbindung / close coupled and fixed connection locomotive – tender



Diesellokomotive BR 106 der DR  
Diesel locomotive class 106 of the DR

Lok		Tender	
IV NEM	91	oo	oo
Art.-Nr: 96151	UVP in €: 159,90		



Dampflokomotive 50 1387 der DR  
Steam locomotive 50 1387 the DR

Lok		Tender	
IV NEM	191	oo	oo
Art.-Nr: 02096	UVP in €: 249,90		

- Ausführung mit Witteblechen und Gieslschlot / with Witte smoke deflectors and Giesl-ejector



Diesellokomotive BR 110 der DR  
Diesel locomotive class 110 of the DR

Lok		Tender	
NEU	IV NEM	116	oo
Art.-Nr: 04589	UVP in €: 155,90		



Dampflokomotive BR 52.80 der DR  
Steam locomotive class 52.80 of the DR

Lok		Tender	
IV NEM	193	oo	oo
Art.-Nr: 02286 A	UVP in €: 249,90		



Diesellokomotive BR 119 „Kramermütze“ der DR  
Diesel locomotive class 119 „Kramermütze“ of the DR

Lok		Tender	
IV NEM	162	oo	oo
Art.-Nr: 02780	UVP in €: 157,50		





Güterzug der DRG, Epoche II.  
(Art. 02094 – 95835 – 01673 – 14126 – 15612 – 501285 – 14282 – 14282)



Personenzug mit Güterbeförderung (PmG) der DRG, Epoche II.  
(Art. 02023 – 13411 – 13208 – 13208 – 13005 – 14124 – 14658 – 14658)



Reisezug der DR in Epoche III/IV.  
(Art. 02020 – 01620 – 16301)



Autoreisezug der DR, Epoche IV.  
(Art. 02450 – 16649 – 16648 – 16720 – 15050)



Personenzug für den Nahverkehr der 1980er Jahre der DR.  
(Art. 04589 – 01667)



Internationaler Schnellgüterzug TEEM (Trans Europ Express Marchandises) in Epoche IV.  
(Art. 02337 – 14690 – 14694 – 15431 – 15584 – 17152 – 95214)



S-Bahn der DR, Epoche IV.  
(Art. 01658 – 13888 – 13888 – 501067)



Elektr Lokomotive BR 218 der DR  
Electric locomotive class 218 of the DR

IV	141						
NEM							PHX12
Art.-Nr: 02450		UVP in €: 169,90					



Elektr Lokomotive BR 243 der DR  
Electric locomotive class 243 of the DR

IV	139						
NEM							PHX12
Art.-Nr: 02375		UVP in €: 169,90					



Elektr Lokomotive BR 250 der DR  
Electric locomotive class 250 of the DR

IV	163						
NEM							PHX12
Art.-Nr: 02337		UVP in €: 169,90					



Elektr Lokomotive BR 211 der DR  
Electric locomotive class 211 of the DR

NEU	IV	135					
	NEM						PHX12
Art.-Nr: 501067		UVP in €: 169,90					



Reisezugwagenset der DR, bestehend aus zwei 4-achsigen Rekowagen 2. Klasse und einem 4-achsigen Reko-Sitz-/Gepäckwagen 2. Klasse  
Passenger coach set of the DR with two 2nd class passenger coaches, one 2nd class passenger coach with baggage compartment

	IV	469					
	NEM						PHX12
Art.-Nr.: 01610 A		UVP in €: 128,50					



Set 01610



Reisezugwagen 2. Klasse der DR  
2nd class passenger coach of the DR

	IV	155					
	NEM						PHX12
Art.-Nr.: 16621		UVP in €: 42,50					



### Technische Eigenschaften unserer Diesel- und E-Lok-Modelle:

- Zahlreiche Modelle wurden überarbeitet und mit neuem Motor ausgestattet, z. B. BR 103, BR 112, BR 118, BR 119, BR 143/243, BR 218, BR 221, BR 250, T 334
- Modelle neuerer Produktion sind mit warm-weißer LED ausgestattet, z. B. BR 103, BR 112, BR 118, BR 119, BR 143/243, BR 218, BR 221, BR 250, V 36, T 435, aber auch Steuerwagen
- Hohes Gewicht durch Zinkdruckguss-Rahmen
- Leistungsfähige Motoren mit Schwunghmassen
- Langlebige und wartungsarme Antriebe
- Zuverlässige Stromabnahme über Bronze-Radschleifer
- Fein detaillierte Kunststoff-Gehäuse
- Weitere Details finden Sie in den Beschreibungen der einzelnen Modelle

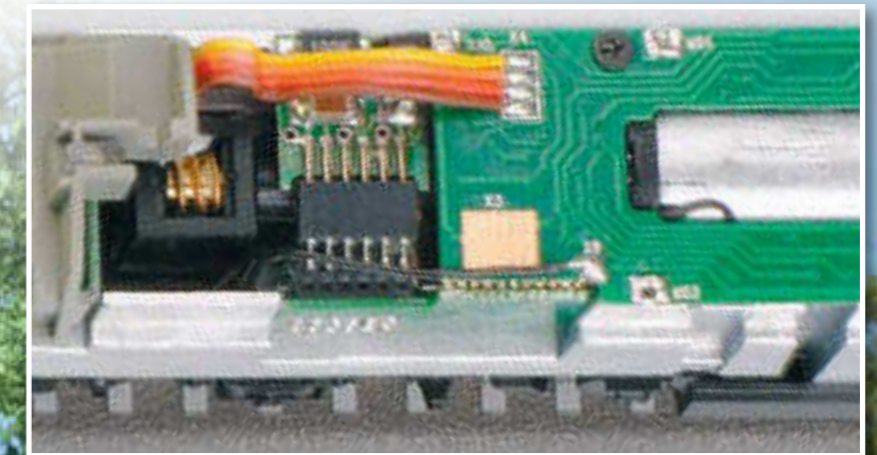

### Technical characteristics of our diesel- and electric locomotives models:

- A lot of revised models are equipped with a new motor (BR 103, BR 112, BR 118, BR 119, BR 143/243, BR 218, BR 221, BR 250, T 334)
- Models in current production are equipped with warm-white LED (BR 103, BR 112, BR 118, BR 119, BR 143/243, BR 218, BR 221, BR 250, V 36, T 435 and driving cab coaches)
- High weight due to the die-cast zinc frame
- High performance motors with flywheels
- Durable and low-maintenance driving units
- Reliable current collection via bronze pick up contacts
- Very detailed plastic housing
- You can find further details in the descriptions of the individual models





Reisezugwagenset der DR, bestehend aus Steuerwagen und Reisezugwagen 2. Klasse, Bauart E5  
 Passenger coach set of the DR with driving cab coach and 2nd class passenger coach, type E5

- Ergänzung zu Art. 13888 / Additional to 13888

NEU	IV NEM	388	Steuerwagen	Handmuster	



Reisezugwagen 2. Klasse, Bauart E5, der DR, mit geänderter Betriebsnummer  
 2nd class passenger coach type E5 of the DR, with different car number

- Ergänzung zu 01658 / Additional to 01658

NEU	IV NEM	193	Handmuster	



Reisezugwagenset „Autoreisezug Dresden-Budapest 1“ der DR, bestehend aus einem Liegewagen Typ B und einem Reko-Sitz-/Gepäckwagen  
 Passenger coach set of the DR „Autoreisezug Dresden-Budapest 1“, with two different passenger coaches

NEU	IV NEM	361	Handmuster	



Reisezugwagenset der DR, bestehend aus einer Doppelstock-Einheit 2. Klasse und einem Packwagen  
 Passenger coach set of the DR, with one 2nd class double-decker coach and one baggage car

NEU	IV NEM	454	Handmuster	



Reisezugwagenset „Autoreisezug Dresden-Budapest 2“ der DR, bestehend aus zwei Schlafwagen WLAB (Typ B) und einem Autotransportwagen DDm, beladen mit drei Trabant 601 und drei Wartburg 353  
 Passenger coach set „Autoreisezug Dresden-Budapest 2“ of the DR, with two passenger coaches WLAB (type B) and one car DDm for automobile transport, loaded with six different cars

- Ergänzung zu Art. 01660 / Additional to 01660

NEU	IV NEM	632	Handmuster	



Reisezugwagen der DR „Tourex 1“; bestehend aus drei verschiedenen Reisezugwagen Typ B  
 Passenger coach set of the DR „Tourex 1“, with three different passenger coaches type B

NEU		621		
Art.-Nr: 01662		UVP in €: 133,90		

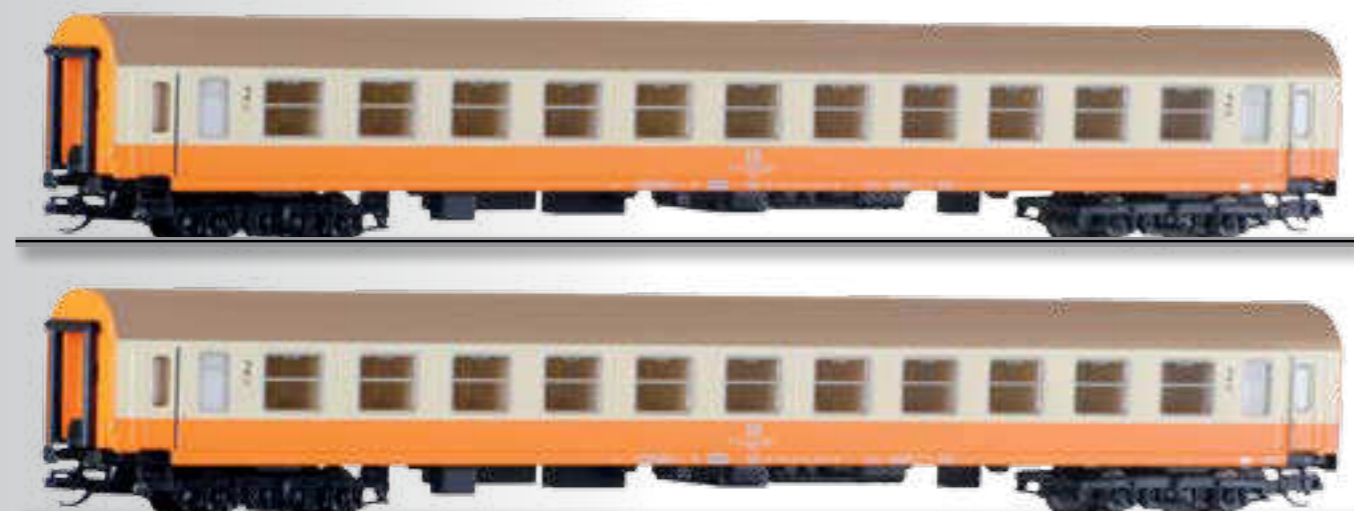

Handmuster

Reisezugwagen der DR „Städteexpress“; bestehend aus zwei Reisezugwagen Bme, Bauart Halberstadt  
 Passenger coach set of the DR „Städteexpress“; with two different passenger coaches Bme, type Halberstadt

NEU		442		
Art.-Nr: 501287		UVP in €: 88,50		



Reisezugwagen der DR, bestehend aus drei D-Zugwagen, Typ B, (1. Kl., 1./2. Kl. und 2. Kl.)  
 Set of 3 passenger coaches, type B, of the DR (1st class, 1st/2nd class and 2nd class)

	616		
Art.-Nr: 01570 A		UVP in €: 124,90	



Set 01570



Reisezugwagen 1. Klasse, Typ Y, der DR  
1st class passenger coach type Y of the DR

Art.-Nr: 16644 A		UVP in €: 42,50			



Reisezugwagen 1./2. Klasse, Typ Y, der DR  
1st/2nd class passenger coach, type Y, of the DR

Art.-Nr: 16648 A		UVP in €: 42,50			



Reisezugwagenset der DR, bestehend aus drei Reisezugwagen, Typ B  
(Schlafwagen, 2. Klasse Personenwagen, Speisewagen)  
Passenger coach set of the DR with three different passenger coaches type B  
(sleeping coach, 2nd class, dining car)

Art.-Nr: 01576 A		UVP in €: 141,90			

Reisezugwagen 2. Klasse, Typ Y, der DR  
2nd class passenger coach, type Y, of the DR

Art.-Nr: 16649 A		UVP in €: 42,50			



Set 01576



Schlafwagen, Typ Y, WLAB „MITROPA“ der DR  
Sleeping coach, type Y, WLAB „MITROPA“ of the DR

Art.-Nr: 16720 A		UVP in €: 51,50			



Speisewagen „MITROPA“ der DR  
Dining car „MITROPA“ of the DR

IV	155	NEU	→	←	→	←	→	←	→
Art.-Nr: 16750		UVP in €: 47,50							



Reisezugwagen 1./2. Klasse, Typ Y/B 70, der DR  
1st/2nd class passenger coach type Y/B 70 of the DR

NEU	→	←	→	←	→	←	→	←	→
Art.-Nr: 16661		UVP in €: 43,50							



Reisezugwagen 2. Klasse, Bauart Halberstadt, der DR  
2nd class passenger coach, type Halberstadt, of the DR

IV	220	NEU	→	←	→	←	→	←	→
Art.-Nr: 13593		UVP in €: 43,50							

- Ausführung mit rehbraunem Dach / with fawn brown roof



Liegewagen 2. Klasse, Typ Y/B 70, der DR  
2nd class couchette coach, type Y/B 70, of the DR

IV	204	NEU	→	←	→	←	→	←	→
Art.-Nr: 16650		UVP in €: 43,50							



Reisezugwagen 1. Klasse, Typ Y/B 70, der DR  
1st class passenger coach type Y/B 70 of the DR

NEU	→	←	→	←	→	←	→	←	→
Art.-Nr: 16660		UVP in €: 43,50							



Reisezugwagen 2. Klasse, Typ Y/B 70, der DR  
2nd class passenger coach, type Y/B 70, of the DR

IV	204	NEU	→	←	→	←	→	←	→
Art.-Nr: 16652		UVP in €: 43,50							



Sitz-/Gepäckwagen 2. Klasse, Typ Y/B 70, der DR  
2nd class passenger coach with baggage compartment, type Y/B 70, of the DR

IV	204	NEU	→	←	→	←	→	←	→
Art.-Nr: 16696		UVP in €: 47,50							

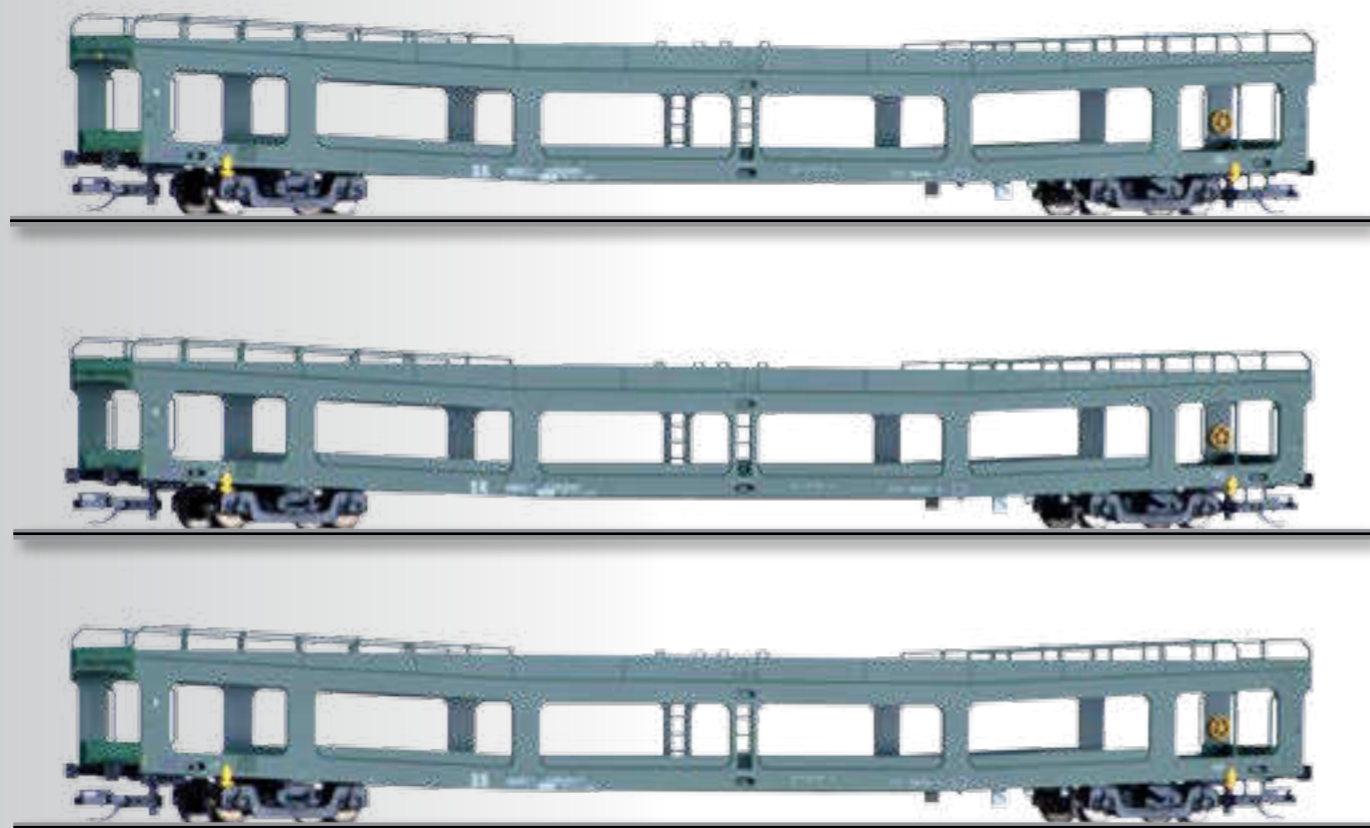

Set der DR, bestehend aus drei Autotransportwagen DDM  
Set of the DR with three different cars DDM for automobile transport

	664	
Art.-Nr: 01636	UVP in €: 118,90	



Autotransportwagen DDM der DR  
Car DDM of the DR for automobile transport

- Ergänzung zu Art. 01636 / additional to set 01636

	220	
Art.-Nr: 15050	UVP in €: 40,50	



Handmuster



Packwagen Pwgs 56 der DR  
Baggage car Pwgs 56 of the DR

	76	
Art.-Nr: 13426	UVP in €: 21,90	

Offener Güterwagen Es 5520 der DR  
Open car Es 5520 of the DR

	83	
Art.-Nr: 17242	UVP in €: 16,50	



Güterwagenset der DR, bestehend aus sechs verschiedenen Güterwagen  
Freight car set of the DR, with six different freight cars

<b>NEU</b>		488	
Art.-Nr: 01643	UVP in €: 99,90		





Säuretopfwagen der DR  
Acid pot car of the DR

	IV	83	□	□	□	□
	NEM1	→	←	→	←	→
Art.-Nr: 14447	UVP in €: 22,50					



Schwenkdachwagen Tdgs für Getreidetransport der DR  
Swing roof car Tdgs „Getreide“ of the DR

- Mit neuer Betriebsnummer erhältlich / with new car number

	IV	81	□	□	□	□
	NEM1	→	←	→	←	→
Art.-Nr: 14574	UVP in €: 34,50					



Handmuster

Postzugset der DR, bestehend aus einem Reko-Postwagen, einem Güterwagen Gbs und einem Containertragwagen Rgs beladen mit drei unterschiedlichen Containern  
Post wagon set of the DR with one mail wagon, one box car Gbs and one container car Rgs loaded with three different containers

NEU	IV	397	□	□	□	□
	NEM1	→	←	→	←	→
Art.-Nr.: 01671	UVP in €: 99,90					



Selbstentladewagen Fcs 6450 der DR  
Hopper car Fcs 6450 of the DR

NEU	IV	81	□	□	□	□
	NEM1	→	←	→	←	→
Art.-Nr: 14587	UVP in €: 34,50					



Güterwagenset der DR, bestehend aus drei gedeckten Güterwagen (1x Gbs 1500, 1x Gbs 1550, 1x Hbs 2300)  
Freight car set of the DR with three box cars (1x Gbs 1500, 1x Gbs 1550, 1x Hbs 2300)

- FORMNEUHEIT / NEW: Bauart Gbs 1500 / box car type Gbs 1500
- Gedeckter Güterwagen Hbs 2300 ohne Inneneinrichtung / box car Hbs 2300 without interior

	IV	355	□	□	□	□
	NEM1	→	←	→	←	→
Art.-Nr: 01631	UVP in €: 105,90					



Offener Güterwagen Eas 5969 der DR mit Pressblechtüren  
Open car Eas 5969 of the DR with pressure plate doors

	IV	117	■	□	□	□	□
	NEM1	→	→	→	→	→	→
Art.-Nr. 15246	UVP in €: 31,90						



Kühlwagen Ibbhqss 8362 der DR  
Refrigerator car Ibbhqss 8362 of the DR

	IV	117	■	□	□	□	□
	NEM1	→	→	→	→	→	→
Art.-Nr. 14690	UVP in €: 36,50						



Schwenkdachwagen Tadgs-y 5843 der DR  
Swing roof car Tadgs-y 5843 of the DR

	IV	159	■	□	□	□	□
	NEM1	→	→	→	→	→	→
Art.-Nr. 15350	UVP in €: 44,90						



Kühlwagen Ibbehs der INTERFRIGO, eingestellt bei der DR  
Refrigerator car INTERFRIGO of the DR

	IV	117	■	□	□	□	□
	NEM1	→	→	→	→	→	→
Art.-Nr. 14694	UVP in €: 36,50						



Selbstentladewagen Facs 6941 der DR  
Hopper car Facs 6941 of the DR

	IV	159	■	□	□	□	□
	NEM1	→	→	→	→	→	→
Art.-Nr. 15370	UVP in €: 41,90						



Schwenkdachwagen Tbekks 5775 der DR  
Swing roof wagon Tbekks 5775 of the DR

	IV	120	■	□	□	□	□
	NEM1	→	→	→	→	→	→
Art.-Nr. 17153	UVP in €: 39,90						



Staubbehälterwagen Uacs-x 9308 der DR  
Silo car Uacs-x 9308 of the DR

NEU	IV	159	■	□	□	□	□
	NEM1	→	→	→	→	→	→
Art.-Nr. 15488	UVP in €: 42,90						



**FORMNEUHEIT:** Niederbordwagen Res der DR, beladen mit zwei Lkw Robur LO 1801 Kofferaufbau der NVA  
**NEW:** Low side car Res of the DR, with two Military van trucks type Robur LO1801

NEU	IV	166	■	□	□	□	□
	NEM1	→	→	→	→	→	→
Art.-Nr. 18101	UVP in €: 61,90						



Containertragwagen Rgs 3910 der DR, beladen mit drei verschiedenen 20"-Containern / Container car Rgs 3910 of the DR, loaded with three different 20"-containers

	IV	166	■	□	□	□
	NEM		→	←	→	←
Art.-Nr.: 15584 A	UVP in €: 35,50					



Güterwagenset der DR, bestehend aus drei Staubsilowagen Ucs mit unterschiedlichen Betriebsnummern  
Freight car set of the DR, with three different silo cars with different car numbers

NEU	IV	214	■	□	□	□
	NEM		→	←	→	←
Art.-Nr.: 01680	UVP in €: 94,90					



Containertragwagen Rgs-z der DR, beladen mit drei verschiedenen 20" Containern / Container car Rgs-z of the DR, loaded with three different 20" container

NEU	IV	166	■	□	□	□
	NEM		→	←	→	←
Art.-Nr.: 18102	UVP in €: 35,90					



Staubsilowagen Ucs der DR  
Silo car Ucs of the DR

	IV	72	■	□	□	□
	NEM		→	←	→	←
Art.-Nr.: 17700	UVP in €: 31,90					



Niederbordwagen Res der DR  
Low side car Res of the DR

- Ausführung der späten Epoche IV mit braunem Fahrwerk / model of the late epoch IV with brown chassis

	IV	166	■	□	□	□
	NEM		→	←	→	←
Art.-Nr.: 15581	UVP in €: 26,90					

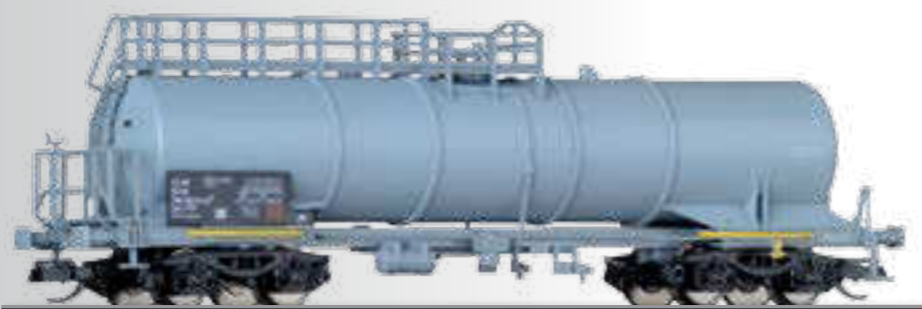
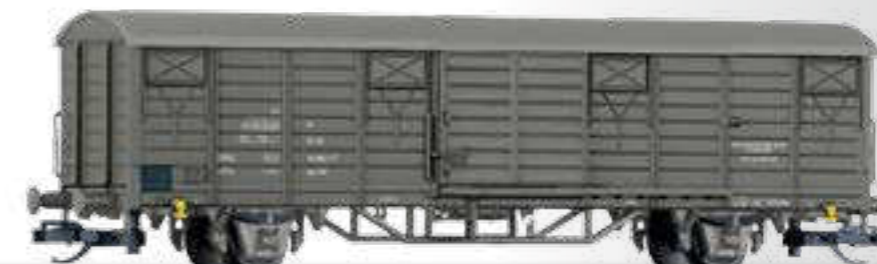

Kesselwagen Zacs der DR  
Tank car Zacs of the DR

	IV	120	■	□	□	□
	NEM		→	←	→	←
Art.-Nr.: 15431	UVP in €: 37,90					



Güterwagenset „VEB Leuna-Werke Walter Ulbricht“, bestehend aus zwei gedeckten Güterwagen Gbs, eingestellt bei der DR  
Freight car set „VEB Leuna-Werke Walter Ulbricht“ with two box cars Gbs of the DR

NEU	IV	236	■	□	□	□
	NEM		→	←	→	←
Art.-Nr.: 501324	UVP in €: 70,90					



Reisezugwagen-set der DR, bestehend aus drei verschiedenen InterRegio-Wagen: 2x Bomz; 1x ARKimbz (Bistro Café)  
 Passenger coach set of the DR, with three different passenger coaches

NEU	V 664	[Symbol]	
Art.-Nr: 501286	UVP in €: 141,90		



Dampflokomotive BR 01 der DB  
 Steam locomotive class 01 of the DB

Lok	Tender
[Symbol] 199	[Symbol]
Art.-Nr: 02131 A	UVP in €: 213,90

- Kurzgekuppelte feste Verbindung Lok – Tender/close coupled and fixed connection locomotive – tender
- Witte-Windleitbleche/smoke deflektor type „Witte“
- Bundesbahn-Pumpen/German Federal Railways-pump type



Foto: Stefan Klein



Diesellokomotive V 200.0 der DB  
 Diesel locomotive class 200.0 of the DB

[Symbol] 152	[Symbol]
Art.-Nr: 02501	UVP in €: 166,90

- Mit erhabenem Schriftzug „Deutsche Bundesbahn“ / with raised letters „Deutsche Bundesbahn“



Elektr locomotive E 40 der DB  
 Electric locomotive class E 40 of the DB

NEU	[Symbol] 135	[Symbol]
Art.-Nr: 02394	UVP in €: 165,50	



Foto: H. Hölscher



Reisezugwagenset „Rheingold 1“ der DB, bestehend aus Elektrolokomotive E 10.12 und zwei Reisezugwagen (AD4üm-62 und Av4üm-62)  
 Passenger coach set „Rheingold 1“ of the DB with electric locomotive class E 10.12 and two different passenger coaches (AD4üm-62 und Av4üm-62)

		575							
Lok					Wagen				
Art.-Nr. 01614					UVP in €: 262,90				

**FORMNEUHEIT:** Reisezugwagenset „Rheingold 2“ der DB, bestehend aus drei verschiedenen Reisezugwagen (Speisewagen WR4üm-62, Reisezugwagen Av4üm-62 und Ap4üm-62)  
**NEW:** Passenger coach set „Rheingold 2“ of the DB, with three different passenger coaches (dining car WR4üm-62, passenger coaches Av4üm-62, Ap4üm-62)

<b>NEU</b>		664			
Art.-Nr. 01651			UVP in €: 143,90		



Foto: S. Klein



Reisezugwagenset der DB, bestehend aus drei Schürzenwagen in F-Zug-Lackierung  
 Passenger coach set of the DB with three different passenger coaches in F-Zug-colouring

	535		
Art.-Nr: 01595		UVP in €: 146,90	



Reisezugwagenset der DB, bestehend aus drei vierachsigen Abteilwagen  
 3. Klasse preußischer Bauart, davon ein Wagen mit Bremserhaus  
 3rd class passenger coach set with three different passenger coaches prussian type  
 of the DB, one of them with brakeman's cab

	469		
Art.-Nr: 01616 A		UVP in €: 162,90	



Set: 01616



Speisewagen (Schürzenwagen) der DB  
 Dining car of the DB

- Ergänzungswagen zu Set 01595 / compatible to set 01595

	196		
Art.-Nr: 16975		UVP in €: 56,90	



Reisezugwagen 1./2. Klasse (Schürzenwagen) der DB  
 1st/2nd passenger coach of the DB

- Ergänzungswagen zu Set 01595 / compatible to set 01595

	177		
Art.-Nr: 16922		UVP in €: 47,50	



Reisezugwagen 3. Klasse preußischer Bauart der DB, mit Bremserhaus  
 3rd class passenger coach prussian type of the DB with brakeman's cab

- Ergänzungswagen zu Set 01616 / compatible to set 01616

	155		
Art.-Nr: 13161 A		UVP in €: 55,90	



Rangierdienst Shunting service	Personenzüge/ Nahverkehr Passenger trains/local train traffic	Eilzüge Express trains	D-Züge/ Fernverkehr Express trains/ long distance travel	Güterverkehr Carriage of goods
-----------------------------------	---	---------------------------	--	--------------------------------------



BR 01



BR 38



BR 50



BR 86



V 36/BR 236 (\*)



V 80/BR 280



BR 215 | V 200/BR 220



E 10.12



E 18/BR 118



E 40/BR 140



(\*) Die V36 ist als DB-Variante für 2015 im Set „Samba-Express II“ erhältlich (Art. 501495, exklusiv für Mitglieder des TILLIG-T-Clubs)



Güterzuggepäckwagen Pwgs-41 der DB  
Baggage car Pwgs-41 of the DB

NEU	III/IV	86	■-□-□-□-□
Art.-Nr: 13476	NEM	NEM	NEM
		UVP in €: 29,90	



Postwagen Post-b/15 der Deutschen Bundespost  
Mail waggon Post -b/15 of the „Deutsche Bundespost“

III	136	■-□-□-□-□
NEM	NEM	NEM
Art.-Nr: 13894 A		UVP in €: 47,50



Foto: K. Brust



Behelfs-Güterzuggepäckwagen (ex Bi-29) der DB  
Baggage car (ex Bi-29) of the DB

NEU	III	116	■-□-□-□-□
Art.-Nr: 16001	NEM	NEM	NEM
		UVP in €: 31,90	



Reisezugwagen 1. Klasse der DB  
1st class passenger coach of the DB

Handmuster	
Art.-Nr.: 13518	UVP in €: 45,50



Steuerwagen „Silberling“ BD4nf der DB  
Driving cap coach „Silberling“ BD4nf of the DB

Am Steuerkopfende	
Art.-Nr.: 13830	UVP in €: 61,90

- Warm-weiße LED-Beleuchtung am Steuerabteil/warm-white LED at the front



Sitz-/Gepäckwagen 2. Klasse der DB  
2nd class passenger coach with baggage compartment of the DB

Handmuster	
Art.-Nr.: 13519	UVP in €: 45,50



Reisezugwagen 1./2. Klasse „Silberling“ AB4n der DB  
1st/2nd class passenger coach „Silberling“ AB4n of the DB

Art.-Nr.: 13851	UVP in €: 39,50



Foto: TILLIG Werksarchiv



Reisezugwagen 2. Klasse „Silberling“ B4n der DB  
2nd class passenger coach „Silberling“ B4n of the DB

Art.-Nr.: 13850	UVP in €: 39,50



Reisezugwageneset der DB, bestehend aus zwei verschiedenen Reisezugwagen (AB4üm, B4üm) und einem Speisewagen (WR4üm-64)

Passenger coach set of the DB, with two different passenger coaches (AB4üm, B4üm) and one dining car (WR4üm-64)

Art.-Nr.: 01623	UVP in €: 145,90





Kühlwagen Tehs 50 der DB  
Refrigerator car Tehs 50  
of the DB

	III	91	→	→	→	→	→	→	→
	NEM								NEM
Art.-Nr:	14017 A	UVP in €:	20,90						



Kleinvieh-Verschlagwagen  
V 23 der DB  
Partition car V 23 for animal  
transport of the DB

	III	83	→	→	→	→	→	→	→
	NEM								NEM
Art.-Nr:	14822 A	UVP in €:	20,50						



Gedeckter Güterwagen Gmms 61  
der DB

Box car Gmms 61 of the DB

- Mit beweglichen Türen/  
with moveable doors

	III	117	→	→	→	→	→	→	→
	NEM								NEM
Art.-Nr:	17150	UVP in €:	35,90						



Gedeckter Güterwagen Gmms 64  
der DB

Box car Gmms 64 of the DB

- Mit beweglichen Türen/  
with moveable doors

	III	117	→	→	→	→	→	→	→
	NEM								NEM
Art.-Nr:	17155	UVP in €:	35,90						



Gedeckter Güterwagen Gltmms  
62 der DB

Box car Gltmms 62 of the DB

- Mit beweglichen Türen/  
with moveable doors

	NEU	III	117	→	→	→	→	→	→
		NEM							NEM
Art.-Nr:	17156	UVP in €:	35,90						

Handmuster



Offener Güterwagen Omm 55  
der DB

Open car Omm 55 of the DB

	III	83	→	→	→	→	→	→	→
	NEM								NEM
Art.-Nr:	17245	UVP in €:	16,50						



Schwenkdachwagen Ktmms 69  
der DB

Swing roof car Ktmms 69 of the  
DB

	III	81	→	→	→	→	→	→	→
	NEM								NEM
Art.-Nr:	14576	UVP in €:	34,50						



Selbstentladewagen Otmm 70  
der DB

Hopper car Otmm 70 of the DB

	NEU	III	81	→	→	→	→	→	→
		NEM							NEM
Art.-Nr:	14586	UVP in €:	34,50						



Niederbordwagen Xt 35 der  
DB, beladen mit Matador  
„DSG“

Low side car Xt 35 of the DB,  
with Matador van „DSG“

	NEU	III	76	→	→	→	→	→	→
		NEM							NEM
Art.-Nr:	14923	UVP in €:	26,90						



Kühlwagen der „Petri  
Fischkonserven“, eingestellt  
bei der DB

Refrigerator car „Petri  
Fischkonserven“ of the DB

	NEU	III	91	→	→	→	→	→	→
		NEM							NEM
Art.-Nr:	17134	UVP in €:	25,50						



Kesselwagen „DEA“,  
eingestellt bei der DB  
Tank car „DEA“ of the DB

- Mit neuer Betriebsnummer erhältlich/  
with new car number

	III	74	■	□	□	□
	NEM	→	NEM			
Art.-Nr: 95830	UVP in €: 29,50					



Staubsilowagen Kds 54 der DB  
Silo car Kds 54 of the DB

- Bauart mit kleinen Behältern/  
type with small silos

	III	72	■	□	□	□
	NEM	→	NEM			
Art.-Nr: 17731	UVP in €: 31,90					



Güterwagenset „Bauzug“ der DB  
Freight car set „Bauzug“ of the DB

NEU	III	272	■	□	□	□
	NEM	→	NEM			
Art.-Nr: 01664	UVP in €: 67,90					



Güterwagenset EUROP, bestehend aus je einem gedeckten Güterwagen  
der DB, der SNCB und der SNCF  
Freight car set EUROP, with three different box cars (one DB, one SNCB, one  
SNCF)

NEU	III	232	■	□	□	□
	NEM	→	NEM			
Art.-Nr: 01652	UVP in €: 70,90					



Foto: TILLIG Werksarchiv



Güterwagenset der DB, bestehend aus sechs verschiedenen Güterwagen (Niederbordwagen  
X05, offener Güterwagen Om12, offener Güterwagen Om55, Kleinvieh-Verschlagwagen V23,  
Säuretopfwagen „EVA“, gedeckter Güterwagen G10)  
Freight car set of the DB with six different freight cars (low side car X05, open car Om12,  
open car Omm55, partition car for animal transport V23, acid pot car „EVA“, box car G10)

Handmuster	III	480	■	□	□	□
	NEM	→	NEM			
Art.-Nr.: 01644	UVP in €: 99,90					



Dampflokotive BR 001 der DB  
Steam locomotive class 001 of the DB

	IV NEM	199	o	o	o	o	o	o	o	o	o	o	o	o
Lok			Tender											
Art.-Nr: 02133			UVP in €: 213,90											



Diesellokotive BR 215 der DB  
Diesel locomotive class 215 of the DB

	IV NEM	137	o	o	o	o	o	o	o	o	o	o	o	o	Handmuster
Art.-Nr: 02712 A			UVP in €: 157,50												



**FORMNEUHEIT:** Dampflokotive BR 038 der DB  
**NEW:** Steam locomotive class 038 of the DB

	NEU	IV NEM	155	o	o	o	o	Rmin 310	o	o	o	o	o	o
Art.-Nr: 02021			UVP in €: 279,90											

- Ausführung mit Witte-Windleitblechen, Indusi und Tender 2'2'T 21,5/  
version with Witte smoke deflectors, Indusi train protection and tender type 2'2'T 21,5



Diesellokotive BR 219 001-5 der DB  
Diesel locomotive class 219 001-5 of the DB

	NEU	IV NEM	137	o	o	o	o	o	o	o	o	o	o	o	Handmuster
Art.-Nr: 02741			UVP in €: 157,50												



Dampflokotive BR 050 der DB  
Steam locomotive class 050 of the DB

	NEU	IV NEM	191	o	o	o	o	Rmin 310	o	o	o	o	o	o
Art.-Nr: 02295			UVP in €: 249,90											



Diesellokotive BR 220 der DB  
Diesel locomotive class 220 of the DB

	IV NEM	152	o	o	o	o	o	o	o	o	o	o	o	o	Handmuster
Art.-Nr: 02500			UVP in €: 157,50												



Dampflokotive 86 457  
des DB-Museums  
Steam locomotive 86 457  
of the DB-museum

	IV NEM	113	o	o	o	o	o	o	o	o	o	o	o	o
Art.-Nr: 02178			UVP in €: 169,90											



Diesellokotive BR 220 der DB  
Diesel locomotive class 220 of the DB

	IV NEM	152	o	o	o	o	o	o	o	o	o	o	o	o	Handmuster
Art.-Nr: 02503			UVP in €: 157,50												



Diesellokomotive BR 280 der DB  
Diesel locomotive class 280 of the DB

<b>NEU</b>	IV NEM	144						
Art.-Nr: 04801		UVP in €: 159,90						



Reisezugwagen 1. Klasse (ex B4ü-38) der DB  
1st class passenger coach (ex B4ü-38) of the DB

	IV NEM	177						
Art.-Nr: 16901 A		UVP in €: 47,50						



Elektrolokomotive BR 118 der DB  
Electric locomotive class 118 of the DB

	IV NEM	141						
Art.-Nr: 02451		UVP in €: 169,90						



Reisezugwagen 1./2. Klasse (ex BC4ü-39) der DB  
1st/2nd class passenger coach (ex BC4ü-39) of the DB

	IV NEM	177						
Art.-Nr: 16921 A		UVP in €: 47,50						



Elektrolokomotive BR 118 der DB  
Electric locomotive class 118 of the DB

<b>NEU</b>	IV NEM	141						
Art.-Nr: 02455		UVP in €: 169,90						

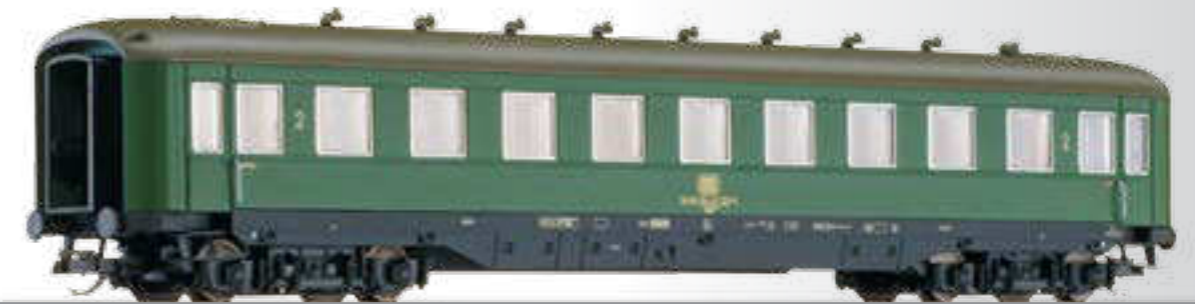

Reisezugwagen 2. Klasse (ex C4ü-38) der DB  
2nd class passenger coach (ex C4ü-38) of the DB

	IV NEM	177						
Art.-Nr: 16941 A		UVP in €: 47,50						



Speisewagen (ex WR4ü-38) der DB  
Dining car (ex WR4ü-38) of the DB

	IV NEM	196						
Art.-Nr: 16971 A		UVP in €: 56,90						



Speisewagen WRm 132 der DB  
Dining car WRm 132 of the DB

	IV NEM	220						
Art.-Nr: 13697		UVP in €: 58,90						



Reisezugwagen 1. Klasse, Apmz 121 der DB, in TEE-Lackierung  
1st class passenger coach Apmz 121 of the DB, in TEE-colouring

- Wagen mit Runddach, Farbgebung mit roter Schürze / with edger roof and red blanket

		220		
Art.-Nr: 13572 A	UVP in €: 46,50			



Foto: TILLIG Werksarchiv

Reisezugwagen 1. Klasse der DB  
1st class passenger coach of the DB

NEU			220		
Art.-Nr: 16503	UVP in €: 45,50				



Reisezugwagen 1. Klasse, Avmz 111 der DB, in TEE-Lackierung  
1st class passenger coach Avmz 111 of the DB, in TEE-colouring

- Wagen mit Runddach, Farbgebung mit roter Schürze / with edger roof and red blanket

		220		
Art.-Nr: 13579 A	UVP in €: 46,50			

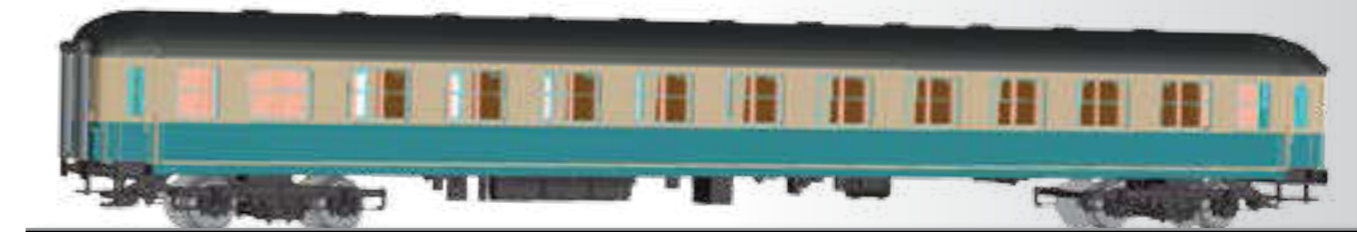

CAD Zeichnung

**FORMNEUHEIT:** Liegewagen 2. Klasse, Bcm 243, der DB  
**NEW:** 2nd class couchette coach Bcm 243 of the DB

NEU			220		
Art.-Nr: 16580	UVP in €: 49,90				



Reisezugwagen 1. Klasse Avmz 207 der DB  
1st class passenger coach Avmz 207 of the DB

- „Eurofima“-Bauart in IC-Farbgebung/„Eurofima“ type in IC-colouring

		220		
Art.-Nr: 13530	UVP in €: 45,50			



Reisezugwagen 2. Klasse Bpmz 291 der DB  
2nd class passenger coach Bpmz 291 of the DB

		220		
Art.-Nr: 16500	UVP in €: 45,50			



Foto: S. Klein



**FORMNEUHEIT:** Speisewagen WRmh 131 der DB  
**NEW:** Dining car WRmh 131 of the DB

NEU			220		
Art.-Nr: 16590	UVP in €: 58,90				



Reisezugwagen 2. Klasse mit Gepäckabteil, BDm, der DB  
2nd class passenger coach with baggage compartment BDm of the DB

NEU			220		
Art.-Nr: 13526	UVP in €: 45,50				



Reisezugwagen „Silberling“ 1./2. Klasse ABn 703 der DB  
1st/2nd class passenger coach „Silberling“ ABn 703 of the DB

		220		
Art.-Nr: 13857	UVP in €: 39,50			



Reisezugwagen „Silberling“ 2. Klasse Bn 719 der DB  
2nd class passenger coach „Silberling“ Bn 719 of the DB

		220		
Art.-Nr: 13856	UVP in €: 39,50			



Reisezugwagen „Silberling“ 2. Klasse, Bnrzb 728, der DB  
2nd class passenger coach „Silberling“, Bnrzb 728, of the DB

		220		
Art.-Nr: 13863	UVP in €: 39,50			

- Wagen mit Steildach / with steep roof



Kesselwagen „VTG“,  
eingestellt bei der DB  
Tank car „VTG“ of the DB

	76	
Art.-Nr: 14479	UVP in €: 25,50	



Kesselwagen „EVA“,  
eingestellt bei der DB  
Tank car „EVA“ of the DB

	92	
Art.-Nr: 14996	UVP in €: 33,90	



Staubsilowagen Ucs 908 der DB  
Silo car Ucs 908 of the DB

- Bauart mit kleinem Behälter/  
version with small silos

	72	
Art.-Nr: 17730	UVP in €: 31,90	



Staubsilowagen Ucs 908  
„Quarzwerte“ der DB  
Silo car Ucs 908 „Quarzwerte“  
of the DB

- Bauart mit kleinem Behälter/  
version with small silos

	72	
Art.-Nr: 17732	UVP in €: 31,90	



Staubsilowagen Ucs 909 „Brandt“ der DB  
Silo car Ucs 909 „Brandt“ of the DB

	Handmuster		
NEU	IV	72	■-□-□-□-□
	NEM	→	NEM
Art.-Nr.: 17761	UVP in €: 31,90		



Güterwagenset der DB, bestehend aus drei Staubsilowagen Ucs 909  
Freight car set of the DB with three different silo cars Ucs 909

	IV	214	■-□-□-□-□
	NEM	→	NEM
Art.-Nr.: 01608 A	UVP in €: 94,90		

- Bauart mit großem Behälter / version with big silos
- Mit neuer Betriebsnummer erhältlich / with new car number



**FORMNEUHEIT:** Wagenset der DB, bestehend aus zwei Autotransportwagen DDm 915  
**NEW:** Set of the DB with two different cars DDm 915 for automobile transport

NEU	IV	442	■-□-□-□-□
	NEM	→	NEM
Art.-Nr.: 01669	UVP in €: 80,50		



Schwerlastwagen Sammp 705 der DB  
Flat car Sammp 705 of the DB

	IV	110	■-□-□-□-□
	NEM	→	NEM
Art.-Nr.: 15610	UVP in €: 35,50		

- Abnehmbare Rungen / changeable stakes



Taschenwagen mit Auflieger der DB  
Pocket wagon of the DB with trailer

	IV	138	■-□-□-□-□
	NEM	→	NEM
Art.-Nr.: 15568	UVP in €: 39,90		



Taschenwagen der DB mit zwei Wechselpritschen  
Pocket wagon of the DB with load

NEU	IV	138	■-□-□-□-□
	NEM	→	NEM
Art.-Nr.: 18151	UVP in €: 39,90		



Schiebewandwagen Sis „RHEINBRAUN“, eingestellt bei der DB  
Sliding cover box car Sis „RHEINBRAUN“, of the DB

	IV	194	■-□-□-□-□
	NEM	→	NEM
Art.-Nr.: 15834 A	UVP in €: 39,90		



Güterwagenset „Bananentransport“ der DB, bestehend aus drei Kühlwagen Ibbhpls 401  
Freight car set „banana transport“ of the DB, with three refrigerator cars Ibbhpls 401

	IV	355	■	→	→	→	→
	NEM						NEM
Art.-Nr: 01630	UVP in €: 107,90						



Kühlwagen Ibbhs 396 der DB  
Refrigerator car Ibbhs 396 of the DB

	IV	117	■	→	→	→	→
	NEM						NEM
Art.-Nr: 14691	UVP in €: 36,50						



Offener Güterwagen Eaos 106 der DB  
Open car Eaos 106 of the DB

- Mit beweglichen Türen / with movable loading doors

	IV	117	■	→	→	→	→
	NEM						NEM
Art.-Nr: 15241 A	UVP in €: 27,50						



Offener Güterwagen Es 040 der DB  
Open car Es 040 of the DB

	IV	76	■	→	→	→	→
	NEM						NEM
Art.-Nr: 17243	UVP in €: 16,50						



Selbstentladewagen Fc 090 der DB  
Hopper car Fc 090 of the DB

	IV	81	■	→	→	→	→
	NEM						NEM
Art.-Nr: 14585	UVP in €: 34,50						



Offener Güterwagen Es 050 der DB, beladen mit Holzabfall  
Open car Es 050 of the DB, loaded with wood waste

	IV	76	■	→	→	→	→
	NEM						NEM
Art.-Nr: 17246 A	UVP in €: 25,50						





Diesellokomotive BR 202 der DB AG, verkehrsrote Farbgebung  
Diesel locomotive class 202 of the DB AG

V	116	NEU	NEU	NEU	NEU	NEU	NEU	NEU	NEU	NEU
Art.-Nr:	04588	UVP in €:		155,90						



Diesellokomotive BR 229 der DB AG  
Diesel locomotive class 229 of the DB AG

NEU	V	162	NEU	NEU	NEU	NEU	NEU	NEU	NEU	NEU
Art.-Nr:	02791	UVP in €:		157,50						



Diesellokomotive BR 245 der DB AG  
Diesel locomotive class 245 of the DB AG

VI	158	NEU	NEU	NEU	NEU	NEU	NEU	NEU	NEU	NEU
Art.-Nr:	04940	UVP in €:		149,90						

- Fernlicht schaltbar mit Decoder Art. 66023 / main beam can be switched on by decoder item-no. 66023



Elektrolokomotive BR 101 der DB AG  
Electric locomotive class 101 of the DB AG

NEU	VI	159	NEU	NEU	NEU	NEU	NEU	NEU	NEU	NEU
Art.-Nr:	02314	UVP in €:		171,50						



Rangierdienst  
Shunting service

Regionalbahn/  
Regionalexpress  
Regional railway/  
regional express  
trains

S-Bahn  
Suburban  
railway

Fernverkehr  
(IC/EC)  
Long distance  
travel (IC/EC)

Güterverkehr  
Carriage of  
goods



BR 202



BR 229



BR 245



BR 101



BR 115



BR 139/BR 140



BR 146



BR 186



BR 189 (\*)



(\*) Die BR 189 ist derzeit in verschiedenen Privatbahn-Varianten der Epoche VI im TILLIG-Programm



Elektr.lokomotive BR 115,  
DB Autozug  
Electric locomotive class  
115, DB Autozug

VI	135	→	☒	☒	☒	☒	☒	☒	☒	☒	☒	☒
NEM	NEM		NEM	NEM	NEM	NEM	NEM	NEM	NEM	NEM	NEM	NEM
UVP in €: 165,50												
Art.-Nr.: 02391												

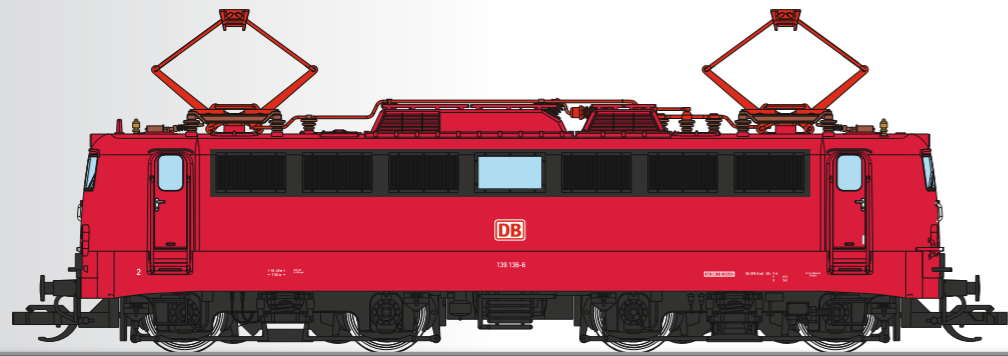

Elektr.lokomotive BR 139 der DB AG  
Electric locomotive class 139 of the DB AG  
• Ausführung in orientroter Farbgebung

NEU	V	135	→	☒	☒	☒	☒	☒	☒	☒	☒	☒
NEM	NEM	NEM		NEM	NEM	NEM	NEM	NEM	NEM	NEM	NEM	NEM
Art.-Nr.: 02395		Handmuster										
UVP in €: 165,50												



Elektr.lokomotive BR 140  
der DB AG  
Electric locomotive class 140  
of the DB AG

V	135	→	☒	☒	☒	☒	☒	☒	☒	☒	☒	☒
NEM	NEM		NEM	NEM	NEM	NEM	NEM	NEM	NEM	NEM	NEM	NEM
UVP in €: 165,50												
Art.-Nr.: 02390												



Elektr.lokomotive BR 186 der DB Schenker  
Electric locomotive class 186 of the DB Schenker

• Fernlicht schaltbar mit Decoder Art. 66023 / Main beam can be switched on by decoder item-no. 66023

VI	158	→	☒	☒	☒	☒	☒	☒	☒	☒	☒	☒
NEM	NEM		NEM	NEM	NEM	NEM	NEM	NEM	NEM	NEM	NEM	NEM
Art.-Nr.: 04900 A		UVP in €: 174,90										



Elektr.lokomotive BR 146.5 der DB AG in aktueller IC-Farbgebung  
Electric locomotive class 146.5 of the DB AG in actual colouring

VI	158	→	☒	☒	☒	☒	☒	☒	☒	☒	☒	☒
NEM	NEM		NEM	NEM	NEM	NEM	NEM	NEM	NEM	NEM	NEM	NEM
Art.-Nr.: 04909		UVP in €: 174,90										

• Fernlicht schaltbar mit Decoder Art. 66023 / Main beam can be switched on by decoder item-no. 66023



ICE 1-Set 2. Klasse der DB AG, bestehend aus zwei Triebköpfen (davon ein Dummy) und einem 2. Klasse Reisezugwagen  
2nd class ICE 1-set of the DB AG, with two traction units (one dummy) and one 2nd class passenger coach

VI	570	→	☒	☒	☒	☒	☒	☒	☒	☒	☒	☒
NEM	NEM		NEM	NEM	NEM	NEM	NEM	NEM	NEM	NEM	NEM	NEM
Art.-Nr.: 01353		UVP in €: 209,90										



Foto: Stefan Klein



ICE 1-Ergänzungsset 1 der DB AG, bestehend aus drei unterschiedlichen Reisezugwagen (1. Kl. Wagen, 2. Kl. Wagen, BordRestaurant)  
ICE 1-additional set 1 of the DB AG with three different passenger coaches (1st class passenger coach, 2nd class passenger coach and dining car)

VI	664	Rmin
NEM	← →	310
Art.-Nr: 01611		UVP in €: 118,90

Set: 01611



ICE 1-Ergänzungsset 2 der DB AG, bestehend aus drei unterschiedlichen Reisezugwagen (1. Kl. Wagen, 2. Kl. Wagen, Servicewagen)  
ICE 1-additional set 2 of the DB AG with three different passenger coaches (1st class, 2nd class, service coach)

VI	664	Rmin
NEM	← →	310
Art.-Nr: 01612		UVP in €: 115,90

Set: 01612



ICE 1-Ergänzungswagen 1. Klasse der DB AG  
1st class passenger coach of the DB AG, additional to ICE 1

VI	220	Rmin
NEM	← →	310
Art.-Nr: 13779		UVP in €: 39,50



ICE 1-Ergänzungswagen 2. Klasse der DB AG  
2nd class passenger coach of the DB AG, additional to ICE 1

VI	220	Rmin
NEM	← →	310
Art.-Nr: 13780		UVP in €: 39,50



Reisezugwagen 1. Klasse, Aimz, der DB AG in InterRegio-Farbgebung  
1st class passenger coach Aimz of the DB AG

NEU	V NEM	220	→	←	→	←	→	←
Art.-Nr: 13522	UVP in €: 45,50							



Reisezugwagen 2. Klasse der DB AG  
2nd class passenger coach of the DB AG

V NEM	155	→	←	→	←	→	←	→
Art.-Nr: 16620	UVP in €: 42,50							



Reisezugwagen 2. Klasse, Bimz, der DB AG in InterRegio-Farbgebung  
2nd class passenger coach Bimz of the DB AG

NEU	V NEM	220	→	←	→	←	→	←
Art.-Nr: 13523	UVP in €: 45,50							



Sitz-/Gepäckwagen 2. Klasse der DB AG  
2nd class baggage car of the DB AG

V NEM	155	→	←	→	←	→	←	→
Art.-Nr: 16601	UVP in €: 46,50							



Reisezugwagen 2. Klasse mit Fahrradabteil, Bimdz, der DB AG in InterRegio-Farbgebung  
2nd class passenger coach with bicycle compartment Bimdz of the DB AG

NEU	V NEM	220	→	←	→	←	→	←
Art.-Nr: 13524	UVP in €: 45,50							



Schlafwagen WLAB, Typ Y, der DB AG  
Sleeping coach WLAB, type Y, of the DB AG

V NEM	204	→	←	→	←	→	←	→
Art.-Nr: 16724	UVP in €: 51,50							



Reisezugwagen 1. Klasse mit Bord Bistro, ARkimbz, der DB AG in InterRegio-Farbgebung  
1st class passenger coach ARkimbz of the DB AG

NEU	V NEM	220	→	←	→	←	→	←
Art.-Nr: 13525	UVP in €: 45,50							



Doppelstockwagen-Einheit 2. Klasse der DB AG  
2nd class double-deck coach of the DB AG

NEU	V NEM	342	→	←	→	←	→	←
Art.-Nr: 13738	UVP in €: 86,90							



Doppelstock-Steuerwagen DBbzf 761.2 der DB AG  
Double-deck driving cab coach DBbzf 761.2 of the DB AG

- Mit DB-Regio-Logo/with company logo DB-Regio

VI	227	Am Steuerkopfende	Rmin 310	Am hinteren Wagenende
NEM				
Art.-Nr: 13802		UVP in €: 89,90		



Steuerwagen Bnrzf 463 der DB AG  
Driving cab coach Bnrzf 463 of the DB AG

- Warm-weiße LED-Beleuchtung/with warm-white LED
- Beleuchtete Zugzielanzeige/lit destination indicator

V	220	Am Steuerkopfende		
NEM				
Art.-Nr: 13842 A		UVP in €: 63,90		



Doppelstockwagen 1./2. Klasse DABz 755 der DB AG  
1st/2nd class Double-deck coach DABz 755 of the DB AG

- Mit DB-Regio-Logo/with company logo DB-Regio

VI	223		Rmin 310	
NEM				
Art.-Nr: 13803		UVP in €: 51,50		



Reisezugwagen 1./2. Klasse ABnrz 418 der DB AG  
1st/2nd class passenger coach ABnrz 418 of the DB AG

- Modernisierte Ausführung mit Festfenstern/modern version
- Mit DB-Regio-Logo/with company logo DB-Regio

VI	220			
NEM				
Art.-Nr: 13860 A		UVP in €: 39,50		



Doppelstockwagen 2. Klasse DBz 750 der DB AG  
2nd class Double-deck coach DBz 750 of the DB AG

- Mit DB-Regio-Logo/with company logo DB-Regio

VI	223		Rmin 310	
NEM				
Art.-Nr: 13800		UVP in €: 51,50		



Reisezugwagen 2. Klasse Bnr 451 der DB AG  
2nd class passenger coach Bnr 451 of the DB AG

- Modernisierte Ausführung mit Festfenstern/modern version
- Mit DB-Regio-Logo/with company logo DB-Regio

VI	220			
NEM				
Art.-Nr: 13861 A		UVP in €: 39,50		



Foto: TILLIG Werksarchiv



Reisezugwagen 2. Klasse, Bnrz 450, der DB AG  
2nd class passenger coach Bnrz 450 of the DB AG

NEU	VI	220		
	NEM			
Art.-Nr: 13864		UVP in €: 39,50		



Reisezugwagen 2. Klasse „München Nürnberg Express“ der DB AG  
2nd class passenger coach „München Nürnberg Express“ of the DB AG

• Ergänzung zu Set 01657 / Additional to set 01657

NEU	VI 220 NEM	Handmuster
Art.-Nr.: 16504	UVP in €: 45,50	



Reisezugwagen 2. Klasse, DB-NachtZug  
2nd class passenger coach of the DB-NachtZug

NEU	VI 220 NEM	
Art.-Nr.: 501279	UVP in €: 45,50	

Passendes Triebfahrzeug:  
E-Lok BR 101,  
Art. 02314  
(siehe S. 96)



Foto: TILLIG Werksarchiv

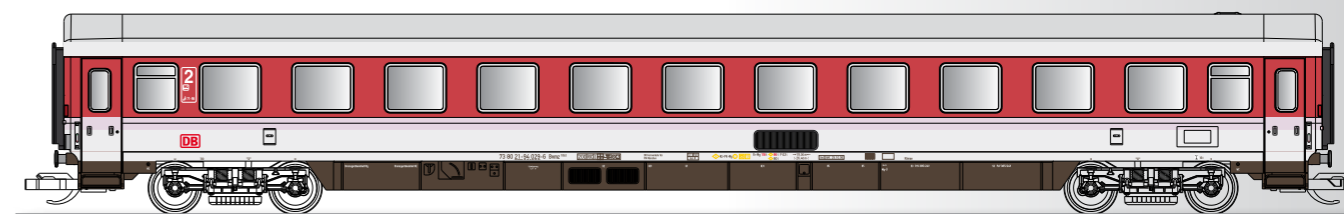

Reisezugwagen Bvmz 185 der DB AG  
Passenger coach Bvmz 185 of the DB AG

NEU	VI 220 NEM	CAD-Zeichnung
Art.-Nr.: 16533	UVP in €: 45,50	



Reisezugwagenset „München Nürnberg Express 2“ der DB AG,  
bestehend aus einem Reisezugwagen 1./2. Klasse und einem  
Reisezugwagen 2. Klasse  
Passenger coach set „München Nürnberg Express 2“ of the DB AG  
with one 1st/2nd passenger coach and one 2nd class passenger coach

NEU	VI 442 NEM	
Art.-Nr.: 01657	UVP in €: 88,50	



Foto: J. Lorenz



Foto: J. Lorenz

Wagenset „DB Systemtechnik“ der DB AG, bestehend aus zwei Messbeiwagen  
(1 x Bimz 259.8 Bauart Halberstadt, 1 x Bim 547.5 m-Wagen)  
Passenger coach set „DB Systemtechnik“ of the DB AG  
(1 x Bimz 259.8 type Halberstadt, 1 x Bim 547.5 type m-Wagen)

NEU	VI 442 NEM	
Art.-Nr.: 01686	UVP in €: 88,50	



Reisezugwagen 2. Klasse Bpmz 291 in alter IC-Farbgebung der DB AG  
2nd class passenger coach Bpmz 291 in old IC-colouring of the DB AG

		220		
Art.-Nr: 16501		UVP in €: 45,50		



Reisezugwagen 1. Klasse Apmz 121 der DB AG, in aktueller IC-Farbgebung  
1st class passenger coach Apmz 121 of the DB AG, in actual IC-colouring

		220		
Art.-Nr: 13571		UVP in €: 45,50		



Reisezugwagen 1. Klasse Avmz 111 der DB AG, in aktueller IC-Farbgebung  
1st class passenger coach Avmz 111 of the DB AG, in actual IC-colouring

		220		
Art.-Nr: 13576		UVP in €: 45,50		



Steuerwagen Bpmbdzf 296.3 der DB AG, in aktueller IC-Farbgebung  
Driving cap coach Bpmbdzf 296.3 of the DB AG in actual colouring

- Steuerwagen in druckdichter Ausführung / cab car in pressure-tight version

Am Steuer-Kopflende		Am hinteren Wagenende	
	220		
Art.-Nr: 13564		UVP in €: 78,50	



Reisezugwagen 2. Klasse Bpmz 291 der DB AG, in aktueller IC-Lackierung  
2nd class passenger coach Bpmz 291 of the DB AG, in actual IC-colouring

		220		
Art.-Nr: 16502		UVP in €: 45,50		



Reisezugwagen 2. Klasse Bpmbkz 291.8 der DB AG „Snack Point“  
2nd class passenger coach Bpmbkz 291.8 of the DB AG

NEU		220		
Art.-Nr: 16505		UVP in €: 45,50		



Reisezugwagen 2. Klasse, Bvmz 111.2 der DB AG, in aktueller IC-Farbgebung  
2nd class passenger coach, Bvmz 111.2 of the DB AG, in actual IC-colouring

		220		
Art.-Nr: 13581		UVP in €: 46,50		



Wagenset der DB AG, bestehend aus drei Autotransportwagen DDm 916  
Set of the DB AG with three different cars DDm 916 for automobile transport

		V	664	
		NEM		NEM
Art.-Nr: 01638		UVP in €: 118,90		



**FORMNEUHEIT:** Autotransportwagen DDm 915 der DB AG  
**NEW:** Car DDm 915 of the DB AG for automobile transport

<b>NEU</b>		V	220	
		NEM		NEM
Art.-Nr: 15051		UVP in €: 40,50		



Wagenset der DB AG, bestehend aus zwei Autotransportwagen DDm 916  
Set of the DB AG with two different cars DDm 916 for automobile transport

		V	442	
		NEM		NEM
Art.-Nr: 01639		UVP in €: 80,50		



Gedeckter Güterwagen  
Gbs 254 der DB AG  
Box car Gbs 254 of the DB AG  
• Mit beweglichen Türen /  
with moveable doors

		V	121	
		NEM		NEM
Art.-Nr: 17154		UVP in €: 36,50		



Wagenset der DB AG, bestehend aus zwei Autotransportwagen DDm 916  
Set of the DB AG with two different cars DDm 916 for automobile transport

<b>NEU</b>		V	442	
		NEM		NEM
Art.-Nr: 01640		UVP in €: 80,50		



Gedeckter Güterwagen  
Gbs 258 der DB AG  
Box car Gbs 258 of the DB AG  
• Mit beweglichen Türen /  
with moveable doors

		V	117	
		NEM		NEM
Art.-Nr: 17158		UVP in €: 34,50		





CAD-Zeichnung

**FORMNEUHEIT:** Güterwagenset, bestehend aus drei offenen Güterwagen Eaos der On Rail GmbH, der DB und der BDZ  
**NEW:** Freight car set with three different open cars Eaos (one On Rail GmbH, one DB, one BDZ)

NEU	V 355	■-□-□-□
Art.-Nr: 01678	UVP in €: 95,50	NEM

**FORMNEUHEIT:** Güterwagenset der DB AG, bestehend aus drei offenen Güterwagen Eaos-x 054  
**NEW:** Freight car set of the DB AG with three different open cars Eaos-x 054

NEU	VI 355	■-□-□-□
Art.-Nr: 01677	UVP in €: 95,50	NEM



Foto. A, Schulz



Standardhilfszug der DB AG, bestehend aus Energieversorgungs-, Geräte- und Aufenthaltswagen  
 Standard maintenance train of the DB AG with three different cars

V 413	■-□-□-□	■-□-□-□
Art.-Nr: 01626	UVP in €: 172,50	NEM



Offener Güterwagen  
Eaos-x 075 der DB AG  
Open car Eaos-x 075 of  
the DB AG

- Eine Tür pro Wagenseite/  
only one door per side

NEU	V	117	□	□	□
	NEM		→	→	→
Art.-Nr: 15247	UVP in €: 31,90				



Selbstentladewagen Fals  
der DB AG  
High capacity hopper  
car Fals of the DB AG

	V	108	□	□	□
	NEM		→	→	→
Art.-Nr: 15281	UVP in €: 29,50				



Offener Güterwagen Eaos-x 075 der DB AG  
Open freight car Eaos-x 075 of the DB AG

- Umbauvariante mit teilweise verschlossenen Türöffnungen /  
rebuild version with partial closed door openings

	VI	117	□	□	□
	NEM		→	→	→
Art.-Nr: 15254 A	UVP in €: 31,90				

Handmuster



Schwenkdachwagen Tadgs-y 958 „Getreide“ der DB AG  
Swing roof car Tadgs-y 958 „Getreide“ of the DB AG

	V	159	□	□	□
	NEM		→	→	→
Art.-Nr: 15351	UVP in €: 44,90				



Foto: E. Kermer



Selbstentladewagen Facs 124 der DB AG  
Hopper car Facs 124 of the DB AG

	V	159	□	□	□
	NEM		→	→	→
Art.-Nr: 15371	UVP in €: 41,90				



Selbstentladewagen Fcs 092 der DB AG  
Hopper car Fcs 092 of the DB AG

NEU	VI	81	□	□	□
	NEM		→	→	→
Art.-Nr: 14588	UVP in €: 34,50				



Schwenkdachwagen Tads „SKW Piesteritz“ der DB AG  
Swing roof car Tads „SKW Piesteritz“ of the DB AG

	V	159	□	□	□
	NEM		→	→	→
Art.-Nr: 15352	UVP in €: 45,90				

Handmuster



Schiebeplanenwagen Rilns 652 „DB Schenker“  
Sliding tarpaulin car Rilns 652 „DB Schenker“

	VI	166	■	→	⇄	⇄	⇄
	NEM		→				
Art.-Nr.: 15743 A	UVP in €: 34,50						



Handmuster ohne Beschriftung

**FORMNEUHEIT:** Doppeltragwagen Sdggnos/Sdggmrs 739 / 744 „Kombiwaggon“ der DB AG  
**NEW:** Container car Sdggnos/Sdggmrs 739/344 „Kombiwaggon“ of the DB AG

NEU	V	285	■	→	⇄	⇄	⇄
	NEM		→				
Art.-Nr.: 18001	UVP in €: 56,90						



Taschenwagen der DB AG, beladen mit zwei Wechsellpritschen  
Pocket wagon of the DB AG with load

NEU	V	138	■	→	⇄	⇄	⇄
	NEM		→				
Art.-Nr.: 15569	UVP in €: 39,90						



Schiebewandwagen Habins der TRANSWAGGON, eingestellt bei der DB AG  
Sliding wall box car Habins „TRANSWAGGON“ of the DB AG

	V	194	■	→	⇄	⇄	⇄
	NEM		→				
Art.-Nr.: 15832 A	UVP in €: 39,90						



Niederbordwagen Res der DB AG, beladen mit Rohren  
Low side car Res of the DB AG loaded with tubes

- Abnehmbare, drehbare Rungen / changeable stakes that can be rotated

	V	166	■	→	⇄	⇄	⇄
	NEM		→				
Art.-Nr.: 15586	UVP in €: 37,90						



Schiebewandwagen Habiins 12 „VW/Audi“, eingestellt bei der DB AG  
Sliding cover box car Habiins 12 „VW/Audi“ of the DB AG

	V	194	■	→	⇄	⇄	⇄
	NEM		→				
Art.-Nr.: 15833 A	UVP in €: 39,90						



Niederbordwagen Res „DB Bahnbau“  
Low side car Res „DB Bahnbau“

- Abnehmbare, drehbare Rungen / changeable stakes that can be rotated
- Mit Schotterladung / loaded with gravel

	V	166	■	→	⇄	⇄	⇄
	NEM		→				
Art.-Nr.: 15575 A	UVP in €: 27,50						



Staubbehälterwagen der KVG, eingestellt bei der DB AG  
Silo car „KVG“ of the DB AG

	V	159	■	→	⇄	⇄	⇄
	NEM		→				
Art.-Nr.: 15496 A	UVP in €: 42,90						



Güterwagenset „VTG“, bestehend aus drei Staubsilowagen Ucs, eingestellt bei der DB AG / Freight car set „VTG“ with three different silo cars Ucs of the DB AG

- Bauart mit kleinen Behältern / version with small silos

V	214	NEU	Handmuster
Art.-Nr.: 01635	UVP in €: 94,90		



Diesellokomotive V60 D, Werklok VEB Leuna-Werke  
Diesel locomotive V60 D of the VEB Leuna-Werke

NEU	91	Handmuster
Art.-Nr.: 96114	UVP in €: 179,90	

**Tipp/Our Tip:**

Einsatz der Privatbahn-Loks in Epoche VI: Diese Triebfahrzeuge werden für zahlreiche Transport-Dienstleistungen auf dem deutschen Schienennetz eingesetzt, insbesondere im Güterverkehr auch sehr oft mit Waggons der DB AG am „Haken“.

Use of the private railway locomotives: These tractive units are employed for numerous transportation services on the German rail network, especially in the carriage of goods sector and also very frequently with carriages of the DB AG on the „hook“.



Staubsilowagen Ucs der KVG, eingestellt bei der DB AG  
Silo car Ucs KVG of the DB AG

NEU	V	72	Handmuster
Art.-Nr.: 17701	UVP in €: 30,50		



Kesselwagen „FUCHS Mineralölwerke“, eingestellt bei der DB AG  
Tank car „FUCHS Mineralölwerke“ of the DB AG

V	76	Handmuster
Art.-Nr.: 14400 A	UVP in €: 25,50	



Kesselwagen „GATX“, eingestellt bei der DB AG  
Tank car „GATX“ of the DB AG

VI	92	Handmuster
Art.-Nr.: 14970 A	UVP in €: 34,50	



Dieseltriebswagen BR 642 der Städtebahn Sachsen  
Rail car class 642 of the Städtebahn Sachsen

- Taufname „Rose von Sebnitz 2.0“

VI	348	Handmuster
Art.-Nr.: 02885 A	UVP in €: 279,90	



Diesellokomotive BR 285 der ITL  
Diesel locomotive class 285 of the ITL

	VI	158	NEM		Plux12
Art.-Nr: 04930 A	UVP in €: 146,90				

- Fernlicht schaltbar mit Decoder Art. 66023 / Main beam can be switched on by decoder item-no. 66023



Diesellokomotive BR 285 der hvle (Havelländische Eisenbahn AG)  
Diesel locomotive class 285 of the hvle

	VI	158	NEM		Plux12
Art.-Nr: 04932 A	UVP in €: 149,90				

- Fernlicht schaltbar mit Decoder Art. 66023 / Main beam can be switched on by decoder item-no. 66023



Diesellokomotive BR 246 der metronom Eisenbahngesellschaft mbH  
Diesel locomotive class 246 of the metronom Eisenbahngesellschaft mbH

	VI	158	NEM		Plux12
Art.-Nr: 04933 A	UVP in €: 149,90				

- Fernlicht schaltbar mit Decoder Art. 66023 / Main beam can be switched on by decoder item-no. 66023



Diesellok Reihe 285 der Express Rail (SK)  
Diesel locomotive class 285 of the Express Rail (SK)

	NEU	VI	158	NEM	Plux12
Art.-Nr: 04934	UVP in €: 149,90				

- Fernlicht schaltbar mit Decoder Art. 66023 / Main beam can be switched on by decoder item-no. 66023



Diesellok MY 1149 der Altmark-Rail

Diesel locomotive MY 1149 of the Altmark-Rail

NEU	VI	158	NEM		Plux12
Art.-Nr: 04536	UVP in €: 159,90				



Elektrolokomotive BR 189 der MRCE, vermietet an ERS Railways  
Electric locomotive class 189 of the MRCE, hired to the ERS Railways

	VI	162	NEM		Plux12
Art.-Nr: 02477 A	UVP in €: 175,90				

- Fernlicht schaltbar mit Decoder Art. 66023 / Main beam can be switched on by decoder item-no. 66023



Elektrolokomotive 189 800 der Muldentaleisenbahnverkehrsgesellschaft mbH  
Electric locomotive class 189 800 of the Muldentaleisenbahnverkehrsgesellschaft mbH

NEU	VI	162	NEM		Plux12
Art.-Nr: 02478	UVP in €: 175,90				

- Fernlicht schaltbar mit Decoder Art. 66023 / Main beam can be switched on by decoder item-no. 66023



Elektrolokomotive BR 186 der ITL  
Electric locomotive class 186 of the ITL

- Fernlicht schaltbar mit Decoder Art. 66023 / Main beam can be switched on by decoder item-no. 66023

VI	158	NEM	Plux12
Art.-Nr: 04901 A	UVP in €: 174,90		



Elektrolokomotive Reihe 186 der CAPTRAIN  
Electric locomotive class 186 of the CAPTRAIN

- Fernlicht schaltbar mit Decoder Art. 66023 / Main beam can be switched on by decoder item-no. 66023

NEU	VI	158	NEM	Plux12
Art.-Nr: 04910	UVP in €: 174,90			



Elektrolokomotive E 186 der RAILPOOL GmbH  
Electric locomotive class 186 of the RAILPOOL GmbH

- Fernlicht schaltbar mit Decoder Art. 66023 / Main beam can be switched on by decoder item-no. 66023

VI	158	NEM	Plux12
Art.-Nr: 04903 A	UVP in €: 179,90		

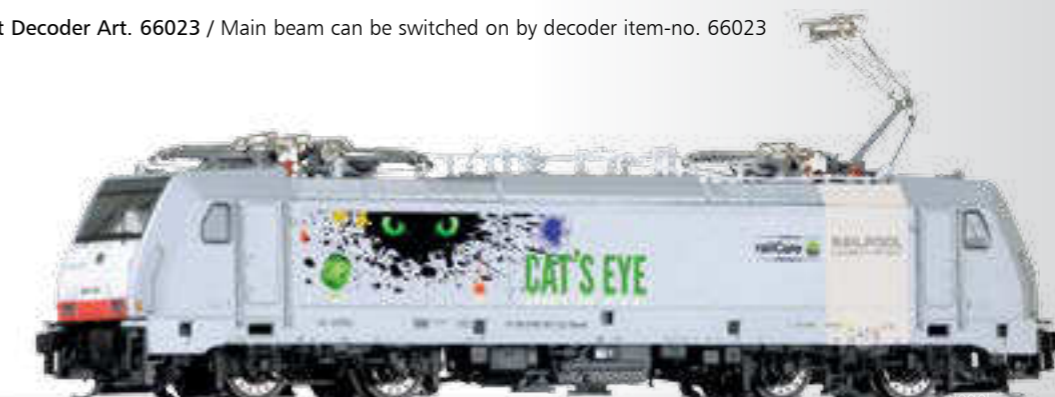

Elektrolokomotive Reihe 186 der RAILPOOL GmbH, vermietet an railCare AG (CH)  
Electric locomotive class 186 RAILPOOL GmbH of the railCare AG (CH)

- Fernlicht schaltbar mit Decoder Art. 66023 / Main beam can be switched on by decoder item-no. 66023

NEU	VI	158	NEM	Plux12
Art.-Nr: 04911	UVP in €: 179,90			



Elektrolokomotive Reihe 186 der EURO CARGO RAIL  
Electric locomotive class 186 of the EURO CARGO RAIL

- Fernlicht schaltbar mit Decoder Art. 66023 / Main beam can be switched on by decoder item-no. 66023

NEU	VI	158	NEM	Plux12
Art.-Nr: 04912	UVP in €: 174,90			



Elektrolokomotive Reihe 186 der RAILPOOL GmbH, vermietet an METRANS (CZ)  
Electric locomotive class 186 RAILPOOL GmbH of the METRANS (CZ)

- Fernlicht schaltbar mit Decoder Art. 66023 / Main beam can be switched on by decoder item-no. 66023

NEU	VI	158	NEM	Plux12
Art.-Nr: 04915	UVP in €: 179,90			

Elektrolokomotive E 186 der OHE (Osthannoversche Eisenbahnen AG)  
Electric locomotive class 186 of the OHE

- Fernlicht schaltbar mit Decoder Art. 66023 / Main beam can be switched on by decoder item-no. 66023

VI	158	NEM	Plux12
Art.-Nr: 04904 A	UVP in €: 179,90		



Elektr Lokomotive E 183 der ARRIVA  
Electric locomotive E 183 of the ARRIVA

Art.-Nr: 04951 A		UVP in €: 178,50	

Fernlicht schaltbar mit Decoder Art. 66023 / Main beam can be switched on by decoder item-no. 66023



Reisezugwagen 1./2. Klasse, ABvmdz, „alex“ der ARRIVA  
1st/2nd class passenger coach Abvmdz „alex“ of the ARRIVA

NEU			
Art.-Nr: 13582	UVP in €: 46,50		

Handmuster



Foto: R. Köthe



Reisezugwagenset „alex“ der ARRIVA, bestehend aus drei Wagen  
(1. Klasse Avmz, 2. Klasse Bm, 2. Klasse Bn) / Passenger coach set „alex“  
of the ARRIVA, one 1st class (Avmz), one 2nd class (Bm), one 2nd class (Bn)

Art.-Nr: 01599 A	UVP in €: 136,50	



Speisewagen BRmz „alex“ der ARRIVA  
Dining car BRmz „alex“ of the ARRIVA

			Handmuster
Art.-Nr: 13698 A	UVP in €: 63,90		

Handmuster



Foto: M. Bäßler

Güterwagenset „Pressnitztalbahn“, bestehend aus zwei Selbstentladewagen Fcs  
 Freight car set „Pressnitztalbahn“ with two different hopper cars Fcs  
 • weitere Modelle der „Pressnitztalbahn“ sind auch in den folgenden Jahren geplant

NEU	VI	164	■	□	□	□	□
	NEM	→	→	→	→	→	→
Art.-Nr: 01679	UVP in €: 67,90						



Kesselwagen Zcs der VTG  
 Tank car Zcs of the VTG

	VI	92	■	□	□	□	□
	NEM	→	→	→	→	→	→
Art.-Nr: 14971	UVP in €: 34,50						



Kesselwagen Zcs der NACCO  
 Tank car Zcs of the NACCO  
 • Mit neuer Betriebsnummer / with new car number

	VI	92	■	□	□	□	□
	NEM	→	→	→	→	→	→
Art.-Nr: 14995	UVP in €: 33,90						



Schiebeplanenwagen „ENVILOC“ der Ahaus Alstätter Eisenbahn GmbH (AAE)  
 Sliding tarpaulin car „ENVILOC“ of the Ahaus Alstätter Eisenbahn GmbH (AAE)

	VI	166	■	□	□	□	□
	NEM	→	→	→	→	→	→
Art.-Nr: 15746	UVP in €: 36,50						



Kesselwagen der GATX  
 Tank car of the GATX

NEU	VI	92	■	□	□	□	□
	NEM	→	→	→	→	→	→
Art.-Nr: 14999	UVP in €: 33,90						



Schiebewandwagen „Jit-Trans“ der GE Rail Services, eingestellt bei der VR  
 Sliding wall box car „Jit-Trans“ of the GE Rail Services

	VI	194	■	□	□	□	□
	NEM	→	→	→	→	→	→
Art.-Nr: 15835	UVP in €: 39,90						



Kesselwagen Zacs der GATX  
 Tank car Zacs of the GATX

	VI	120	■	□	□	□	□
	NEM	→	→	→	→	→	→
Art.-Nr: 15469	UVP in €: 40,50						





Kesselwagen „HOYER“ der ERMEWA  
Tank car „HOYER“ of the ERMEWA

NEU	VI	120	■	□	□	□	□
Art.-Nr: 15473	NEM	→	←	→	←	→	←
		UVP in €: 40,50					



Güterwagenset der MEG, bestehend aus drei Staubsilowagen Ucs 909  
Freight car set of the MEG with three different silo cars Ucs 909

- Bauart mit großen Behältern / version with big silos
- Mit neuer Betriebsnummer / with new car number

	VI	214	■	□	□	□	□
Art.-Nr: 01609 A	NEM	→	←	→	←	→	←
		UVP in €: 94,90					



Staubbehälterwagen „KIELHOLZ-RYBICKI“ der GATX  
Silo car „KIELHOLZ-RYBICKI“ of the GATX

	VI	159	■	□	□	□	□
Art.-Nr: 15490 A	NEM	→	←	→	←	→	←
		UVP in €: 42,90					



Staubbehälterwagen Uacs-y „cebe“ der ERWEMA  
Silo car Uacs-y „cebe“ of the ERWEMA

	VI	159	■	□	□	□	□
Art.-Nr: 15492	NEM	→	←	→	←	→	←
		UVP in €: 42,90					

**TIPP:**

Regelmäßige TT-Sonderserien werden für die polnischen Modellbahnfreunde durch unseren Importeur in Polen (Firma AMC, Kontakt siehe S. 232) angeboten.

Regular TT special series are offered for the Polish model railway enthusiasts through our importer in Poland (AMC company, see page 232 for contact).



Dampflokotive Reihe Ty 5 der PKP  
Steam locomotive class Ty 5 of the PKP

III	191	oo	oo	Rmin	310	■	□	□	□
NEM	→	←	→	NEM	→	←	→	←	→
		UVP in €: 249,90							



Güterwagenset „Militärtransport“, bestehend aus zwei Schwerlastwagen der PKP, beladen mit Panzer T34/85  
Freight car set „military transport“ with two flat cars of the PKP, loaded with two tanks type T34/85

NEU	VI	222	■	□	□	□	□
Art.-Nr: 01674	NEM	→	←	→	←	→	←
		UVP in €: 102,90					



Offener Güterwagen Wddo (ex Breslau) der PKP  
Open car Wddo (ex Breslau) of the PKP

III	76	■	□	□	□	□	□
NEM	→	←	→	←	→	←	→
		UVP in €: 17,50					

Gedeckter Güterwagen Kdt (ex. Oppeln) der PKP  
Box car Kdt (ex. Oppeln) of the PKP

III	76	■	□	□	□	□	□
NEM	→	←	→	←	→	←	→
		UVP in €: 26,90					



Schwerlastwagen PPPzk 303 der PKP, beladen mit einer Holzkiste  
Flat car PPPzk 303 of the PKP, loaded with a wooden box

III	110	■	□	□	□	□	□
NEM	→	←	→	←	→	←	→
		UVP in €: 45,90					



Güterwagenset der PKP, bestehend aus sechs verschiedenen Güterwagen  
Freight car set of the PKP with six different freight cars

Handmuster		NEU	III	480	■-□-□-□	■-□-□-□
		Art.-Nr.: 01646	NEM	→	←	NEM
				UVP in €: 99,90		



Kesselwagen Rh der PKP  
Tank car of the PKP

	III	74	■-□-□-□	■-□-□-□
	NEM	→	←	NEM
		UVP in €: 28,50		



Doppelstockwagen-Einheit 2. Klasse der PKP  
2nd class double-deck coach of the PKP

NEU	IV	342	■-□-□-□	■-□-□-□
	NEM	→	←	NEM
		UVP in €: 86,90		



Schnellzugwagen 2. Klasse, Typ Y/B 70, der PKP  
2nd class passenger coach, type Y/B 70, of the PKP

IV	204	■-□-□-□	■-□-□-□
NEM	→	←	NEM
		UVP in €: 42,50	



Schlafwagen WLAB, Typ Y, der PKP  
Sleeping coach WLAB, type Y, of the PKP

IV	204	■-□-□-□	■-□-□-□
NEM	→	←	NEM
		UVP in €: 51,50	



Offener Güterwagen Es der PKP  
Open car Es of the PKP

IV	76	■-□-□-□	■-□-□-□
NEM	→	←	NEM
		UVP in €: 16,50	



Güterwagenset „Militärtransport“, bestehend aus zwei Schwerlastwagen der PKP, beladen mit Panzer BMP-1 / Freight car set „military transport“ with two flat cars of the PKP, loaded with two tanks type BMP-1

IV	220	■-□-□-□	■-□-□-□
NEM	→	←	NEM
		UVP in €: 102,90	

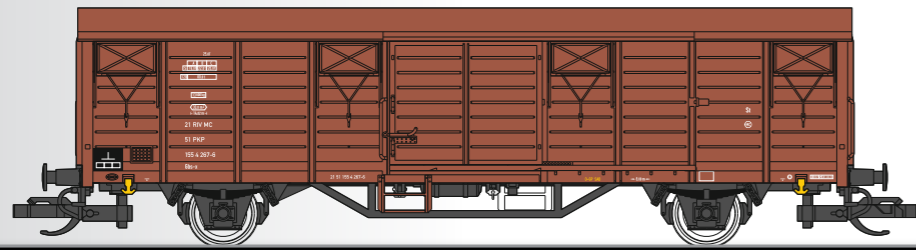

CAD-Zeichnung

Gedeckter Güterwagen Gbs-x der PKP  
Box car Gbs-x of the PKP

NEU	IV-V	117	⊂	⊂	⊂	⊂
	NEM		←	→	←	→
Art.-Nr: 17160	UVP in €: 35,90					



Doppelstockwagen-Einheit 2. Klasse der PKP, bestehend aus zwei Endwagen  
2nd class double-deck coach of the PKP

NEU	V-VI	342	⊂	⊂	⊂	⊂
	NEM		←	→	←	→
Art.-Nr: 13739	UVP in €: 86,90					



Doppelstockwagen-Einheit 2. Klasse der PKP, bestehend aus zwei Mittelwagen  
2nd class double-deck coach of the PKP

NEU	V-VI	281	⊂	⊂	⊂	⊂
	NEM		←	→	←	→
Art.-Nr: 13748	UVP in €: 71,50					



Elektrolokomotive Reihe 370 der PKP INTERCITY  
Electric locomotive class 370 of the PKP INTERCITY

• Fernlicht schaltbar mit Decoder Art. 66023 / Main beam can be switched on by decoder item-no. 66023

	VI	163	⊂	⊂	⊂	⊂
	NEM		←	→	←	→
Art.-Nr: 04953	UVP in €: 179,90					



Reisezugwagen 1. Klasse Adnmu der PKP INTERCITY  
1st class passenger coach Adnmu of the PKP INTERCITY

	VI	220	⊂	⊂	⊂	⊂
	NEM		←	→	←	→
Art.-Nr: 13536	UVP in €: 47,50					

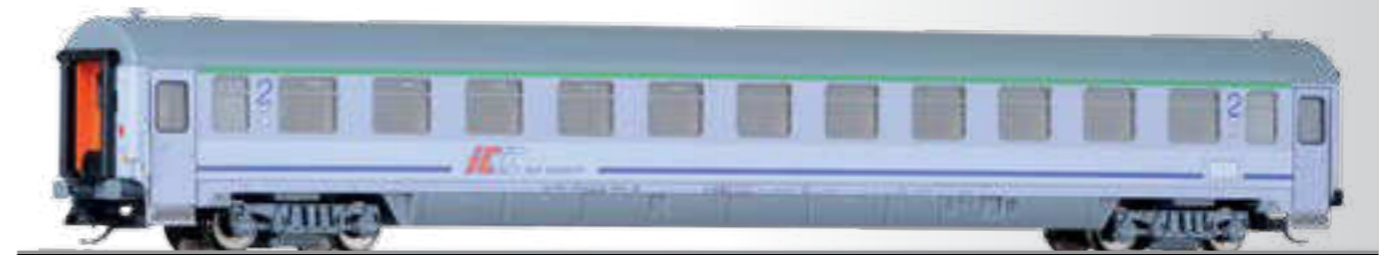

Reisezugwagen 2. Klasse Bdnmu der PKP INTERCITY  
2nd class passenger coach Bdnmu of the PKP INTERCITY

	VI	220	⊂	⊂	⊂	⊂
	NEM		←	→	←	→
Art.-Nr: 13553	UVP in €: 47,50					



Reisezugwagen 2. Klasse Typ Y/B 70 der PKP INTERCITY  
2nd class passenger coach type Y/B 70 of the PKP INTERCITY

• mit geänderter Betriebsnummer / with different car number

NEU	VI	204	⊂	⊂	⊂	⊂
	NEM		←	→	←	→
Art.-Nr.: 16662	UVP in €: 43,50					



Schlafwagen WLAB, Typ Y, der PKP INTERCITY  
Sleeping coach WLAB, type Y, of the PKP INTERCITY

	VI	204	⊂	⊂	⊂	⊂
	NEM		←	→	←	→
Art.-Nr: 16727	UVP in €: 51,50					



Offener Güterwagen Eaos der PKP Cargo  
Open freight car Eaos of the PKP Cargo

	VI	117	oo	oo	oo	oo	oo	oo	oo
	NEM								NEM
Art.-Nr: 15253 A	UVP in €: 31,90								



Selbstentladewagen Fals der PKP Cargo  
High capacity hopper car Fals of the PKP Cargo

	VI	108	oo	oo	oo	oo	oo	oo	oo
	NEM								NEM
Art.-Nr: 15280	UVP in €: 29,50								



**FORMNEUHEIT:** Dampflokomotive Reihe 377.0 der ČSD  
**NEW:** Steam locomotive class 377.0 of the ČSD

- Ausführung mit schwarzem Fahrwerk

• CAD Zeichnung

NEU	III	166	oo	oo	Rmin	oo	oo	oo	oo
	NEM				310				NEM 662
Art.-Nr: 02024	UVP in €: 279,90								



Dampflokomotive BR 555.1 der ČSD  
Steam locomotive class 555.1 of the ČSD

III	191	oo	oo	Rmin	oo	oo	oo	oo	oo
NEM				310					NEM
Art.-Nr: 02299	UVP in €: 249,90								

**TIPP:**

Regelmäßige TT-Sonderserien werden für die tschechischen Modellbahnfreunde durch unsere tschechische Auslandsvertretung (Firma DS Model, Kontakt siehe S. 232) angeboten.

Regular TT special series are offered for the Czech model railway enthusiasts through our importer in Czech Republic (DS Model company, see page 232 for contact).



Dampflokomotive Reihe 455.2 der ČSD  
Steam locomotive class 455.2 of the ČSD

NEU	III	113	oo	oo	oo	oo	oo	oo	oo
	NEM								NEM
Art.-Nr: 02180	UVP in €: 169,90								



Diesellokomotive T 435 der ČSD  
Diesel locomotive class T 435 of the ČSD

III	105	oo	oo	oo	oo	oo	oo	oo	oo
NEM									NEM
Art.-Nr: 04621	UVP in €: 169,90								



Diesellokomotive T 334.0 der ČSD  
Diesel locomotive T 334.0 of the ČSD

III	77	oo	oo	oo	oo	oo	oo	oo	oo
NEM									NEM
Art.-Nr: 04635	UVP in €: 139,90								



Diesellokomotive T 334 der ČSD  
Diesel locomotive class T 334 of the ČSD

- Überarbeitung mit neuem Motor / New motor

III	80	oo	oo	oo	oo	oo	oo	oo	oo
NEM									NEM
Art.-Nr: 04611	UVP in €: 88,90								



Personenwagen 2. Klasse  
(ex Bi-29) der ČSD  
2nd class passenger coach  
(ex Bi-29) of the ČSD

III	116	NEU	NEU
Art.-Nr: 13009	UVP in €: 31,90		



Personenwagen 2. Klasse  
(ex BCi-29) der ČSD  
2nd class passenger coach  
(ex BCi-29) of the ČSD

III	116	NEU	NEU
Art.-Nr: 13018	UVP in €: 31,90		



Postwagen Post4-b/15  
der ČSD  
Mail waggon Post4-b/15  
of the ČSD

III	136	NEU	NEU
Art.-Nr: 13892	UVP in €: 46,50		



Handmuster

Güterwagenset der ČSD, bestehend aus sechs verschiedenen  
Güterwagen  
Freight car set of the ČSD with six different freight cars

NEU	480	NEU	NEU
Art.-Nr: 01645	UVP in €: 99,90		



Speisewagen (ex WR4ü-38) der ČSD  
Dining car (ex WRü4-38) of the ČSD

III	196	NEU	NEU
Art.-Nr: 16972 A	UVP in €: 56,90		



Foto: TILLIG Werksarchiv



Doppelstockwagen-Einheit 2. Klasse der ČSD  
2nd class double-deck coach of the ČSD

NEU	623	NEU	NEU
Art.-Nr: 01357	UVP in €: 152,90		

Handmuster



Offener Güterwagen Vtu  
(ex. Breslau) der ČSD  
Open car Vtu (ex. Breslau)  
of the ČSD

	III	76	■	□	□	□
	NEM	→	→	→	→	→
Art.-Nr: 14276	UVP in €: 17,50					



Niederbordwagen Np der ČSD  
Low side car Np of the ČSD

NEU	III	76	■	□	□	□
	NEM	→	→	→	→	→
Art.-Nr: 14922	UVP in €: 16,50					



Gedeckter Güterwagen Z der ČSD  
Box car Z of the ČSD

NEU	III	76	■	□	□	□
	NEM	→	→	→	→	→
Art.-Nr.: 17133	UVP in €: 23,50					

Handmuster



Kühlwagen La der ČSD  
Refrigerator car La of the ČSD

	III	136	■	□	□	□
	NEM	→	→	→	→	→
Art.-Nr: 15321 A	UVP in €: 34,50					



Kesselwagen Rf der ČSD,  
Tank car Rf of the ČSD

NEU	III	76	■	□	□	□
	NEM	→	→	→	→	→
Art.-Nr: 17301	UVP in €: 25,50					



Gedeckter Güterwagen Zr  
(ex. Oppeln) der ČSD / Box car  
Zr (ex. Oppeln) of the ČSD

	III	76	■	□	□	□
	NEM	→	→	→	→	→
Art.-Nr: 95211	UVP in €: 26,90					



Diesellokomotive T 334 der ČSD  
Diesel locomotive T 334 der ČSD

	IV	80	■	□	□	□
	NEM	→	→	→	→	→
Art.-Nr: 04614	UVP in €: 88,90					



Diesellok Reihe T 435 der ČSD  
Diesel locomotive class T 435 of the ČSD

- Ausführung mit Schwannenhals-Drehgestellen

NEU	IV	105	■	□	□	□
	NEM	→	→	→	→	→
Art.-Nr: 04627	UVP in €: 169,90					



Güterwagenset „Militärtransport“, bestehend aus einem gedeckten Güterwagen Zr  
(ex. Oppeln) und zwei Schwerlastwagen Px der ČSD, beladen mit Panzer T 34/85

- Panzer mit drehbarem Turm und beweglicher Kanone

Freight car set „military transport“ with one box car Zr (ex. Oppeln)  
and two flat cars Px of the ČSD, loaded with two tanks type T 34/85

- Tank with turnable turret and moveable muzzle

	III	260	■	□	□	□
	NEM	→	→	→	→	→
Art.-Nr: 01628	UVP in €: 128,50					

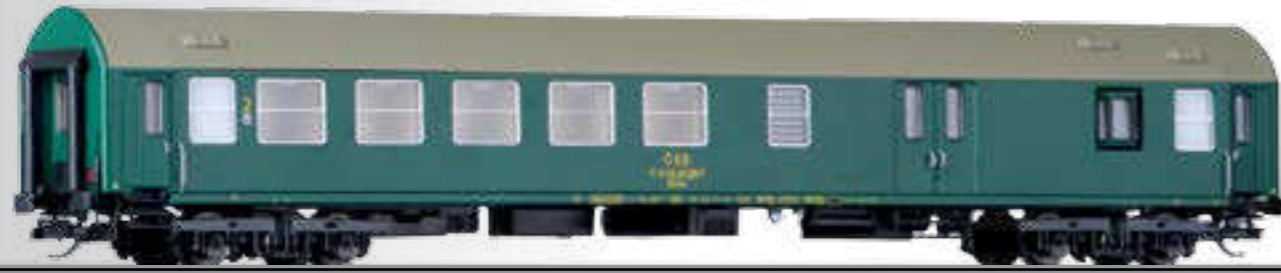

Sitz-/Gepäckwagen 2. Klasse, Typ Y/B 70, der ČSD  
2nd class passenger coach with baggage compartment, type Y/B 70, of the ČSD

	204	
Art.-Nr: 16697	UVP in €: 47,50	



Reisezugwagen 2. Klasse, Typ Y, der ČSD  
2nd class passenger coach, type Y, of the ČSD

	204	
Art.-Nr: 16640	UVP in €: 42,50	

• Mit neuer Betriebsnummer erhältlich / with new car number



Liegewagen 2. Klasse, Typ Y, der ČSD  
2nd class couchette coach, type Y, of the ČSD

	204	
Art.-Nr: 16651	UVP in €: 42,50	



Schlafwagen WLAB, Typ Y, der ČSD  
Sleeping coach WLAB, type Y, of the ČSD

	204	
Art.-Nr: 16723 A	UVP in €: 51,50	



Reisezugwagen 1. Klasse, Typ Y, der ČSD  
1st class passenger coach, type Y, of the ČSD

	204	
Art.-Nr: 16647	UVP in €: 42,50	



Weitstreckenschlafwagen WLABmv, Typ Y, der ČSD  
Sleeping coach WLABmv, type Y, of the ČSD

	204	
Art.-Nr: 16701	UVP in €: 48,90	



Reisezugwagen 1./2. Klasse, Typ Y, der ČSD  
1st/2nd class passenger coach, type Y, of the ČSD

	204	
Art.-Nr: 16643	UVP in €: 42,50	



Doppelstockwagen-Einheit 2. Klasse der ČSD  
2nd class double-deck coach of the ČSD

NEU		342	
Art.-Nr: 13731	UVP in €: 86,90		

Handmuster



Gedeckter Güterwagen Gbs der ČSD  
Box car Gbs of the ČSD

- Mit beweglichen Laderaumtüren / with moveable doors

	IV	117	■	□	□	□
	NEM		→	←	→	←
Art.-Nr: 17151	UVP in €: 35,90					



Offener Güterwagen Eas der ČSD  
Open car Eas of the ČSD

	IV	117	■	□	□	□
	NEM		→	←	→	←
Art.-Nr: 15250	UVP in €: 31,90					



Kühlwagen Ibbhqs der ČSD  
Tank car Ibbhqs of the ČSD

	IV	117	■	□	□	□
	NEM		→	←	→	←
Art.-Nr: 14695	UVP in €: 36,50					



Gedeckter Güterwagen Gklm / Zr der ČSD  
Box car Gklm / Zr of the ČSD

NEU	IV	76	■	□	□	□
	NEM		→	←	→	←
Art.-Nr: 95214	UVP in €: 26,90					



Offener Güterwagen Vte der ČSD  
Open car Vte of the ČSD

	IV	83	■	□	□	□
	NEM		→	←	→	←
Art.-Nr: 14266 A	UVP in €: 16,50					



Gedeckter Güterwagen Gbqs der ČD  
Box car Gbqs of the ČD

NEU	V	117	■	□	□	□
	NEM		→	←	→	←
Art.-Nr: 17159	UVP in €: 35,90					

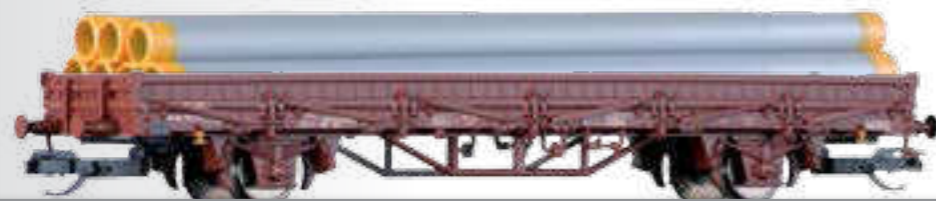

Niederbordwagen Ks der ČSD, beladen mit Rohren  
Low side car Ks of the ČSD with load

NEU	IV	117	■	□	□	□
	NEM		→	←	→	←
Art.-Nr: 14759	UVP in €: 27,50					



Niederbordwagen Res der ČD  
Low side car Res of the ČD

- Abnehmbare, drehbare Rungen / changeable stakes that can be rotated

	V	166	■	□	□	□
	NEM		→	←	→	←
Art.-Nr: 15571	UVP in €: 26,90					



Schwerlastwagenset der ČSD, bestehend aus zwei Schwerlastwagen Salp/Px, beladen mit Panzer BMP-1 der tschechoslowakischen Volksarmee  
Flat car set of the ČSD with two flat cars Salp/Px load with tank BMP-1 of the „Tschechoslowakische Volksarmee“

	IV	222	■	□	□	□
	NEM		→	←	→	←
Art.-Nr: 01606 A	UVP in €: 102,90					





Diesellokomotive T 334 der ČD  
Diesel locomotive class T 334 of the ČD  
• Überarbeitung mit neuem Motor/new motor

V	80	→	←	•••••
Art.-Nr: 04613 A	UVP in €: 88,90			



Elektrolokomotive 1216 235-2 „ČD Railjet / Spirit of Brno“  
Electric locomotive 1216 235-2 „ČD Railjet / Spirit of Brno“  
• eingestellt bei den ÖBB

NEU	VI	163	→	←	•••••	Plus12
Art.-Nr: 04962	UVP in €: 177,90					



Schlafwagen WLAB, Typ Y, der ČD  
Sleeping coach WLAB, type Y, of the ČD

V	204	→	←	•••••
Art.-Nr: 16725	UVP in €: 51,50			



Reisezugwagenset der ČD, bestehend aus einem Reisezugwagen 1. Klasse, Ampz und einem Reisezugwagen 2. Klasse, Bmz  
Passenger coach set of the ČD with two different passenger coaches (one 1st class Ampz and one 2nd class Bmz)

NEU	VI	442	→	←	•••••
Art.-Nr: 01659	UVP in €: 89,90				



Reisezugwagen 1./2. Klasse, Typ Y/B 70, der ČD  
1st/2nd class passenger coach, type Y/B 70, of the ČD

V	204	→	←	•••••
Art.-Nr: 16653	UVP in €: 43,50			



Reisezugwagen 2. Klasse, Typ Y/B 70, der ČD  
2nd class passenger coach, type Y/B 70, of the ČD

V	204	→	←	•••••
Art.-Nr: 16656	UVP in €: 43,50			



Reisezugwagen 2. Klasse, Bmz der ČD  
2nd class passenger coach Bmz of the ČD

NEU	VI	220	→	←	•••••
Art.-Nr: 16534	UVP in €: 45,90				

Handmuster

Handmuster



Reisezugwagen 1. Klasse, Typ Y/B 70, der ČD  
1st class passenger coach, type Y/B 70, of the ČD

	204	
Art.-Nr: 16645	UVP in €: 43,50	



Reisezugwagen 2. Klasse, Typ Y/B 70 mit Fahrradabteil, der ČD  
2nd class passenger coach with bicycle compartment type Y/B 70 of the ČD

NEU		204	
Art.-Nr: 16664	UVP in €: 43,50		



Reisezugwagen 1./2. Klasse, Typ Y/B 70, der ČD  
1st/2nd class passenger coach, type Y/B 70, of the ČD

	204	
Art.-Nr: 16657	UVP in €: 43,50	



Sitz-/Gepäckwagen 2. Klasse, Typ Y/B 70, der ČD  
2nd class passenger coach with baggage compartment, type Y/B 70, of the ČD

	204	
Art.-Nr: 16695	UVP in €: 47,50	



Reisezugwagen 2. Klasse, Typ Y/B 70, der ČD  
2nd class passenger coach, type Y/B 70, of the ČD

	204	
Art.-Nr: 16646	UVP in €: 43,50	



Reisezugwagen 1. Klasse Ampz der ČD  
1st class passenger coach Ampz of the ČD

- Für den Einsatz im EuroCity-Verkehr, passend zu Rh 1216 der ÖBB (04952) und BR 101 DB AG (02314)/for EuroCity trains

	220	
Art.-Nr: 16520	UVP in €: 45,50	



Foto: E. Kermer

Liegewagen 2. Klasse, Typ Y/B 70, der ČD  
2nd class couchette coach type Y/B 70 of the ČD

NEU		204	
Art.-Nr: 16663	UVP in €: 43,50		



Reisezugwagen 2. Klasse Bmz der ČD  
2nd class passenger coach Bmz of the ČD

- Für den Einsatz im EuroCity-Verkehr, passend zu Rh 1216 der ÖBB (04952) und BR 101 DB AG (02314)/for EuroCity trains

	220	
Art.-Nr: 16530	UVP in €: 45,50	



Reisezugwagen 2. Klasse, Bmz der ČD mit „e-tiket“-Aufschrift  
2nd class passenger coach Bmz „e-ticket“ of the ČD

NEU	VI NEM	220	→	→	→	→	→
Art.-Nr: 16532	UVP in €: 46,50						



CAD Zeichnung

FORMNEUHEIT Wagenset der ČD, bestehend aus zwei Autotransportwagen DDm 915

NEW Set of the ČD with two different cars DDm 915 for automobile transport

NEU	VI NEM	442	→	→	→	→	→
Art.-Nr: 01670	UVP in €: 80,50						



Abb. zeigt H0-Modell

Schlafwagen WLAB, Typ Y, der ČD  
Sleeping coach WLAB type Y of the ČD

NEU	VI NEM	204	→	→	→	→	→
Art.-Nr: 16728	UVP in €: 51,50						



Selbstentladewagen Falls der ČD Cargo  
High capacity hopper car Falls of the ČD Cargo

	VI NEM	108	→	→	→	→	→
Art.-Nr: 15298	UVP in €: 29,50						



Schwenkdachwagen TdgnS der ČD Cargo  
Swing roof car TdgnS of the ČD Cargo

NEU	VI NEM	81	→	→	→	→	→
Art.-Nr: 14577	UVP in €: 34,50						



Wagenset der ČD, bestehend aus zwei Autotransportwagen DDm  
Set with two different cars DDm of the ČD for automobile transport

	VI NEM	442	→	→	→	→	→
Art.-Nr: 01641	UVP in €: 80,50						



Kühlwagen Ibbhs der ČD Cargo  
Refrigerator car Ibbhs of the ČD Cargo

	VI NEM	117	→	→	→	→	→
Art.-Nr: 14693	UVP in €: 36,50						



Offener Güterwagen Eaos „AX-Benet“, eingestellt bei der ČD  
Open car Eaos „AX-Benet“ of the ČD

	VI NEM	117	→	→	→	→	→
Art.-Nr: 15252 A	UVP in €: 31,90						



Kesselwagen Zaes der ČD Cargo  
Tank car Zaes of the ČD Cargo

VI	120	→	←	→	←	→	←	→	←	→	←	→
NEM												
Art.-Nr: 15471		UVP in €: 40,50										



Schiebeplanenwagen Rils-y der ČD Cargo  
Sliding tarpaulin car Rils-y of the ČD Cargo

VI	166	→	←	→	←	→	←	→	←	→	←	→
NEM												
Art.-Nr: 15745 A		UVP in €: 35,50										



Schiebewandwagen Habbillns der ČD Cargo  
Sliding cover box car Habbillns of the ČD Cargo

NEU	VI	194	→	←	→	←	→	←	→	←	→	←	→
	NEM												
Art.-Nr: 15804		UVP in €: 39,90											



Staubbehälterwagen Uacns „Lhoist“, eingestellt bei der ČD  
Silo car Uacns „Lhoist“ of the ČD

VI	159	→	←	→	←	→	←	→	←	→	←	→
NEM												
Art.-Nr: 15494		UVP in €: 42,90										

- Mit neuer Betriebsnummer erhältlich / with new car number



Diesellokomotive Rh 720 der ŽSR  
Diesel locomotive class 720 of the ŽSR

V	105	→	←	→	←	→	←	→	←	→	←	→
NEM												
Art.-Nr: 04625 A		UVP in €: 169,90										



Reisezugwagen 1./2. Klasse, Typ Y/B 70, der ZSSK  
1st/2nd class passenger coach, type Y/B 70, of the ZSSK

VI	204	→	←	→	←	→	←	→	←	→	←	→
NEM												
Art.-Nr: 16658		UVP in €: 43,50										



Reisezugwagen 2. Klasse, Typ Y/B 70, der ZSSK  
2nd class passenger coach, type Y/B 70, of the ZSSK

VI	204	→	←	→	←	→	←	→	←	→	←	→
NEM												
Art.-Nr: 16659		UVP in €: 43,50										



Weitstreckenschlafwagen WLAB, Typ Y, der ZSSK  
Sleeping coach WLAB, type Y, of the ZSSK

VI	204	→	←	→	←	→	←	→	←	→	←	→
NEM												
Art.-Nr: 16704		UVP in €: 51,50										



Schlafwagen WLAB, Typ Y, der ZSSK  
Sleeping coach WLAB type Y of the ZSSK

NEU	VI NEM	204	Handmuster
Art.-Nr: 16729	UVP in €: 51,50		



Weitstreckenschlafwagen WLABm, Typ Y, der RZD  
Sleeping coach WLABm, type Y, of the RZD

VI NEM	VI NEM	204	
Art.-Nr: 16702 A	UVP in €: 51,50		

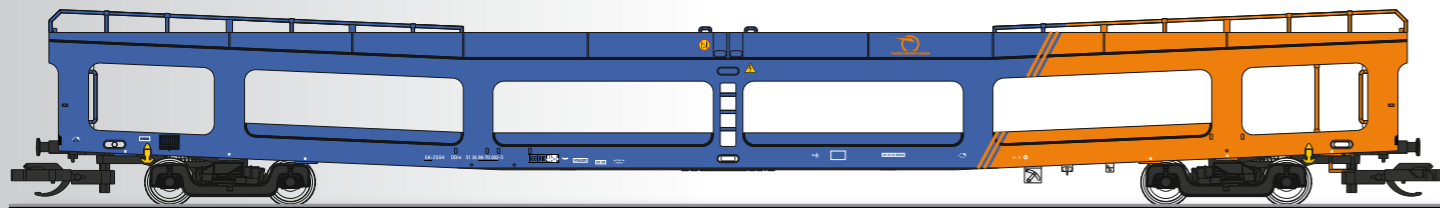
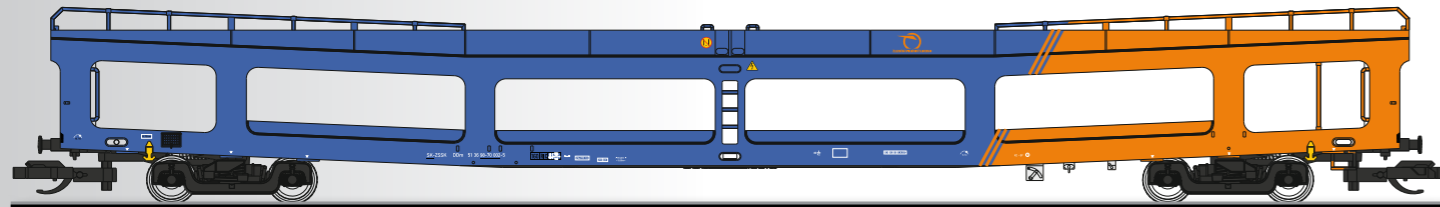

Wagenset der ZSSK, bestehend aus zwei Autotransportwagen DDM 916  
Set of the ZSSK with two different cars DDM 916 for automobile transport

NEU	VI NEM	442	CAD Zeichnung
Art.-Nr: 01668	UVP in €: 80,50		



Weitstreckenschlafwagen WLABme, Typ Y, der RZD  
Sleeping coach WLABme, type Y, of the RZD

VI NEM	VI NEM	204	
Art.-Nr: 16703	UVP in €: 51,50		



Diesellokomotive Reihe ChME2 der SZD  
Diesel locomotive class ChME2 of the SZD

NEU	IV NEM	105	
Art.-Nr: 04628	UVP in €: 169,90		



Dampflokomotive Rh 52 der ÖBB  
Steam locomotive Rh 52 of the ÖBB

III NEM	193	oo	oo	oo	oo	oo	oo	oo	oo
Art.-Nr: 02285	UVP in €: 249,90								



Weitstreckenschlafwagen WLABm (Typ Y) der SZD  
Sleeping car WLABm (type Y) of the SZD

IV NEM	204		
Art.-Nr: 16700	UVP in €: 48,90		



Diesellokomotive 2065.01 der ÖBB  
Diesel locomotive 2065.01 of the ÖBB

III NEM	77	oo	oo	oo	oo	oo	oo	oo	oo
Art.-Nr: 04632 A	UVP in €: 139,90								



Elektr Lokomotive 1118.01 der ÖBB  
Electric locomotive 1118.01 of the ÖBB

	141,5									
Art.-Nr: 02452		UVP in €: 169,90								

- Antrieb überarbeitet, neue Räder, Rahmenblenden, geänderte Dachausrüstung / revised engine, new wheels, frame cover plate, changed roof equipment



Reisezugwagen-Set der ÖBB, bestehend aus drei Schürzenwagen  
(1./2. Klasse, 2. Klasse und 2. Klasse/Buffer)  
Passenger coach set of the ÖBB with three different passenger coaches  
(1st/2nd class, 2nd class and 2nd class/buffet car)

	554									
Art.-Nr: 01596		UVP in €: 148,90								



Set: 01596



Personenwagen 1./2. Klasse ABiph (ex Bi-29) der ÖBB  
1st/2nd class passenger coach ABiph (ex Bi-29) of the ÖBB

	116									
Art.-Nr: 13004		UVP in €: 31,90								



Personenwagen 2. Klasse, Biph (ex Bi-29) der ÖBB  
2nd class passenger coach Biph (ex Bi-29) of the ÖBB

	116									
Art.-Nr: 13008		UVP in €: 31,90								



Personenwagen 2. Klasse, Bih (ex BCI-29) der ÖBB  
2nd class passenger coach Bih (ex BCI-29) of the ÖBB

	116									
Art.-Nr: 13017		UVP in €: 31,90								



Gepäckwagen Pwi der ÖBB  
Baggage wagon Pwi of the ÖBB

	116									
Art.-Nr: 13417		UVP in €: 27,50								



Güterzugbegleitwagen  
(ex Pwgs 41) der ÖBB  
Baggage car (ex Pwgs 41)  
of the ÖBB

	86									
Art.-Nr: 13475		UVP in €: 29,90								



Gedeckter Güterwagen Gms der ÖBB  
Box car Gms of the ÖBB

	III	76	□	□	□	□
	NEM	→	NEM			
Art.-Nr: 95213	UVP in €: 26,90					



Offener Güterwagen Om der ÖBB  
Open car Om of the ÖBB

	III	76	□	□	□	□
	NEM	→	NEM			
Art.-Nr: 14278	UVP in €: 17,50					



Kesselwagen „ÖMV“, eingestellt bei den ÖBB  
Tank car „ÖMV“ of the ÖBB

	III	74	□	□	□	□
	NEM	→	NEM			
Art.-Nr: 95831 A	UVP in €: 27,50					



Kesselwagen der ÖMV, eingestellt bei den ÖBB  
Tank car ÖMV of the ÖBB

NEU	III-IV	76	□	□	□	□
	NEM	→	NEM			
Art.-Nr: 17300	UVP in €: 25,50					



Staubsilowagen Ucs der ÖBB  
Silo car Ucs of the ÖBB

- Bauart mit kleinen Behältern / version with small silos

	IV	72	□	□	□	□
	NEM	→	NEM			
Art.-Nr: 17733	UVP in €: 31,90					



Reisezugwagen 2. Klasse Bmoz der ÖBB  
2nd class passenger coach Bmoz of the ÖBB

NEU	IV	220	□	□	□	□
	NEM	→	NEM			
Art.-Nr: 13558	UVP in €: 45,50					



Handmuster ohne Beschriftung

FORMNEUHEIT Doppeltragwagen Sdggnos/Sdggmrs 739 / 744 Ökombi, der ÖBB  
NEW Container car Sdggnos/Sdggmrs 739/344 of the ÖBB

NEU	V	285	□	□	□	□
	NEM	→	NEM			
Art.-Nr: 18002	UVP in €: 56,90					



Elektr locomotive Rh 1216 der ÖBB  
Electric locomotive Rh 1216 of the ÖBB

VI	163	□	□	□	□	□
NEM	→	NEM				
Art.-Nr: 04952	UVP in €: 177,90					

- Fernlicht schaltbar mit Decoder Art. 66023 / Main beam can be switched on by decoder item-no. 66023



Reisezugwagen 1. Klasse Amz der ÖBB  
1st class passenger coach Amz of the ÖBB

VI	220	□	□	□	□	□
NEM	→	NEM				
Art.-Nr: 13535	UVP in €: 46,50					



Reisezugwagen 2. Klasse Bmz der ÖBB  
2nd class passenger coach Bmz of the ÖBB

V	VI	220	□	□	□	□
NEM	NEM	→	NEM			
Art.-Nr: 13550	UVP in €: 45,50					



Reisezugwagen 2. Klasse Bmz „Kinder-Kino“, der ÖBB  
2nd class passenger coach Bmz „Kinder-Kino“ of the ÖBB

NEU	VI 220	☐	☐	☐	☐
Art.-Nr. 13555	UVP in €: 43,90				

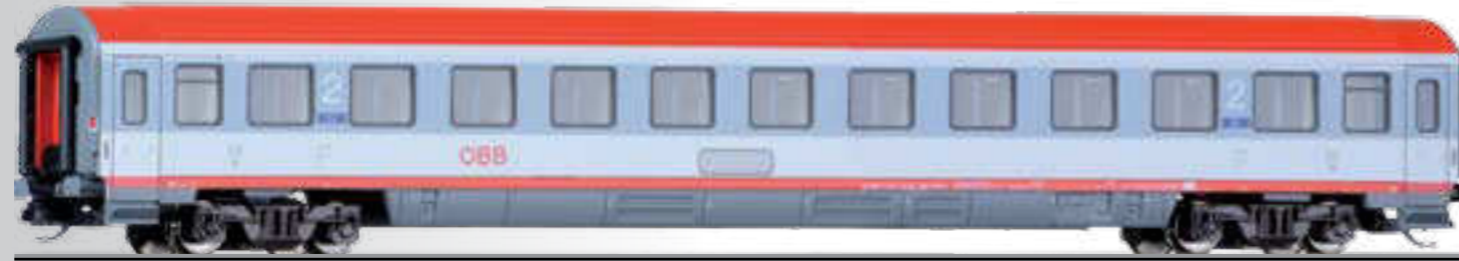

Reisezugwagen 2. Klasse Bmz der ÖBB  
2nd class passenger coach Bmz of the ÖBB

☐	☐	☐	☐	☐	☐
Art.-Nr. 16531	UVP in €: 45,50				



Schwenkdachwagen Tds „Austria Glas Recycling“ der ÖBB  
Swing roof car „Austria Glas Recycling“ of the ÖBB

☐	VI 81	☐	☐	☐	☐
Art.-Nr. 14575	UVP in €: 34,50				



Offener Güterwagen Eas der ÖBB  
Open car Eas of the ÖBB  
• Neue Bauform der Türen / new doors version

☐	VI 117	☐	☐	☐	☐
Art.-Nr. 15248	UVP in €: 31,90				



Niederbordwagen Ks der ÖBB, beladen mit Container „HOCHTIEF“  
Low side car Ks of the ÖBB with container „HOCHTIEF“

☐	VI 117	☐	☐	☐	☐
Art.-Nr. 14756 A	UVP in €: 28,50				

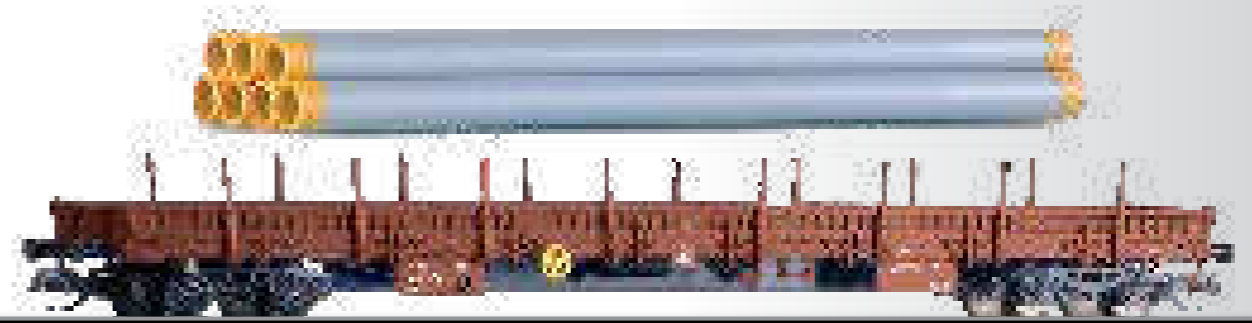

Niederbordwagen Res der ÖBB, beladen mit Rohren  
Low side car Res of the ÖBB with load

NEU	VI 166	☐	☐	☐	☐
Art.-Nr. 18103	UVP in €: 37,90				



Elektrolokomotive 1216 950 der WLC (Wiener Lokalbahnen Cargo GmbH)  
Electric locomotive 1216 950 of the WLC (Wiener Lokalbahnen Cargo GmbH)

☐	VI 163	☐	☐	☐	☐
Art.-Nr. 04954 A	UVP in €: 178,50				

- Fernlicht schaltbar mit Decoder Art. 66023 / Main beam can be switched on by decoder item-no. 66023



Elektrolokomotive 1216 960 der Steiermarkbahn  
Electric locomotive 1216 960 of the Steiermarkbahn

☐	VI 163	☐	☐	☐	☐
Art.-Nr. 04956	UVP in €: 177,90				

- Fernlicht schaltbar mit Decoder Art. 66023 / Main beam can be switched on by decoder item-no. 66023



Staubbehälterwagen Uacs „Lenzing“ der VTG  
Silo car Uacs „Lenzing“ of the VTG

☐	VI 159	☐	☐	☐	☐
Art.-Nr. 15491	UVP in €: 42,50				





Diesellokomotive M61 der MAV  
Diesel locomotive class M61 of the MAV

NEU	IV	158	☺	☹	☹	☹	☹	☹
	NEM			NEM			Plus12	
Art.-Nr.: 04535		UVP in €: 159,90						



Gedeckter Güterwagen Gbgs der MAV  
Box car Gbgs of the MAV

	IV	117	☹	☹	☹	☹	☹	☹
	NEM			NEM				
Art.-Nr.: 17152		UVP in €: 35,90						



Reisezugwagen 1. Klasse, Typ Y/B 70, der MAV  
1st class passenger coach type Y/B 70 of the MAV

NEU	IV	204	☺	☹	☹	☹	☹	☹
	NEM			NEM				
Art.-Nr.: 16665		UVP in €: 43,50						



Elektrolokomotive Reihe 480 der MAV  
Electric locomotive class 480 of the MAV

VI	158	☺	☹	☹	☹	☹	☹	☹
NEM				NEM			Plus12	
Art.-Nr.: 04908		UVP in €: 174,90						

- Fernlicht schaltbar mit Decoder Art. 66023 / Main beam can be switched on by decoder item-no. 66023



Reisezugwagen 2. Klasse, Typ Y/B 70, der MAV  
2nd class passenger coach, type Y/B 70, of the MAV

	IV	204	☺	☹	☹	☹	☹	☹
	NEM			NEM				
Art.-Nr.: 16641		UVP in €: 43,50						



Reisezugwagen 2. Klasse By der MAV-Start  
2nd class passenger coach By of the MAV-Start

VI	220	☺	☹	☹	☹	☹	☹	☹
NEM				NEM				
Art.-Nr.: 13592		UVP in €: 43,50						



Schlafwagen WLAB, Typ Y, der MAV  
Sleeping car WLAB, type Y, of the MAV

	IV	204	☺	☹	☹	☹	☹	☹
	NEM			NEM				
Art.-Nr.: 16721		UVP in €: 48,90						



Reisezugwagenset der MAV-Start, bestehend aus zwei Reisezugwagen Bauart Halberstadt (1./2. Klasse (AByee) und 2. Klasse (Bydee) in aktueller Lackierung)  
Passenger coach set of the MAV-Start, type Halberstadt (one 1st/2nd class (AByee) and one 2nd class (Bydee) in actual colouring)

VI	442	☺	☹	☹	☹	☹	☹	☹
NEM				NEM				
Art.-Nr.: 01625		UVP in €: 88,50						



Offener Güterwagen Eaos der MAV  
Open car Eaos of the MAV

	IV	117	☹	☹	☹	☹	☹	☹
	NEM			NEM				
Art.-Nr.: 15256		UVP in €: 31,90						



Schlafwagen WLAB, Typ Y, der MAV  
Sleeping coach WLAB, type Y, of the MAV

		204		
Art.-Nr: 16726		UVP in €: 51,50		



Niederbordwagen Res der MAV  
Low side car Res of the MAV

<b>NEU</b>		166		
Art.-Nr: 18105		UVP in €: 29,50		



Selbstentladewagen Fals der MAV Cargo  
Hopper car Fals of the MAV Cargo

<b>NEU</b>		108		
Art.-Nr: 15300		UVP in €: 28,90		



Rungenwagen Rgs der MAV, beladen mit Rohren  
Stake car Rgs of the MAV with load

	166		
Art.-Nr: 15582 A		UVP in €: 37,90	

- Abnehmbare, drehbare Rungen / changeable stakes that can be rotated



Schiebewandwagen Habbins der MAV  
Sliding wall box car Habbins of the MAV

	194		
Art.-Nr: 15803		UVP in €: 39,90	



Reisezugwagenset der GYSEV, bestehend aus drei verschiedenen Reisezugwagen (AByz, Byz, BDyz)  
Passenger coach set of the GYSEV with three different passenger coaches

<b>NEU</b>		664		
Art.-Nr: 01688		UVP in €: 128,50		



Offener Güterwagen Eaos der GYSEV Cargo  
Open freight var Eaos of the GYSEV Cargo

<b>NEU</b>		117		
Art.-Nr: 15257		UVP in €: 31,90		



Kesselwagen Zas „MOL“, eingestellt bei der GYSEV  
Tank car Zas „MOL“ of the GYSEV

	VI	120	■	□	■	□
	NEM		→	←	→	←
Art.-Nr:	15467		UVP in €: 40,50			



Kesselwagen Zaes der GYSEV, für Lebensmitteltransporte  
Tank car Zaes of the GYSEV

	NEU	V	120	■	□	■	□
		NEM		→	←	→	←
Art.-Nr:	15475		UVP in €: 40,50				



Kühlwagen Ibbehs der CFR  
Refrigerator car Ibbehs of the CFR

		IV	117	■	□	■	□
		NEM		→	←	→	←
Art.-Nr:	14692 A		UVP in €: 36,50				



Kesselwagen Zas „MARFA“ der CFR  
Tank car Zas „MARFA“ of the CFR

		VI	120	■	□	■	□
		NEM		→	←	→	←
Art.-Nr:	15468 A		UVP in €: 40,50				



Gedeckter Güterwagen „Weintransportwagen“,  
eingestellt bei den SBB  
Box car „Weintransportwagen“ of the SBB

	NEU		76	■	□	■	□
		NEM		→	←	→	←
Art.-Nr:	14127		UVP in €: 23,50				



Reisezugwagen 1. Klasse, Am, der SBB  
1st class passenger coach Am of the SBB

	NEU	IV	220	■	□	■	□
		NEM		→	←	→	←
Art.-Nr:	13539		UVP in €: 45,50				



Liegewagen 2. Klasse, Bcm, der SBB  
2nd class couchette coach Bcm of the SBB

	NEU	IV	220	■	□	■	□
		NEM		→	←	→	←
Art.-Nr:	13556		UVP in €: 45,50				



Offener Güterwagen Eaos der SBB  
Open car Eaos of the SBB

		IV	117	■	□	■	□
		NEM		→	←	→	←
Art.-Nr:	15255		UVP in €: 31,90				



Niederbordwagen Res der SBB  
Low side car Res of the SBB

		V	166	■	□	■	□
		NEM		→	←	→	←
Art.-Nr:	15587		UVP in €: 29,50				



Schiebewandwagen Habbis 345 der SBB  
Sliding cover box car Habbis 345 of the SBB

	V	194	■	□	□	□	□	□
	NEM	→	→	→	→	→	→	→
Art.-Nr: 15802	UVP in €: 39,90							



Taschenwagen der HUPAC, beladen mit zwei Wechsellpritschen „PLANZER“  
Pocket wagon of the HUPAC with load

NEU	V	138	■	□	□	□	□	□
	NEM	→	→	→	→	→	→	→
Art.-Nr: 18150	UVP in €: 39,90							



Elektr lokomotive E 186 der RAILPOOL GmbH, vermietet an SBB Cargo  
Electric locomotive class 186 of the RAILPOOL GmbH, hired of the SBB Cargo

	VI	158	⊕	⊕	⊕	⊕	⊕	⊕
	NEM	→	→	→	→	→	→	→
Art.-Nr: 04907	UVP in €: 179,90							



Elektr lokomotive Reihe 482 „INFRALEUNA“ der SBB Cargo  
Electric locomotive class 482 „INFRALEUNA“ of the SBB Cargo

- Umsetzung des TRAXX2-Vorbildes auf Basis des vorhandenen TILLIG-Modells der TRAXX2E / Freelance model based on electric locomotive TRAXX2E

NEU	VI	158	⊕	⊕	⊕	⊕	⊕	⊕
	NEM	→	→	→	→	→	→	→
Art.-Nr: 501323	UVP in €: 177,90							



Reisezugwagen 1. Klasse Am der SBB  
1st class passenger coach Am of the SBB

- Bauart „Eurofima“, passend für EuroCity-Züge/„Eurofima“ type, for EuroCity trains

	VI	220	⊕	⊕	⊕	⊕	⊕	⊕
	NEM	→	→	→	→	→	→	→
Art.-Nr: 13532	UVP in €: 45,50							



Liegewagen 2. Klasse Bcm der SBB  
2nd class sleeping coach Bcm of the SBB

- Bauart „Eurofima“/„Eurofima“ type

	VI	220	⊕	⊕	⊕	⊕	⊕	⊕
	NEM	→	→	→	→	→	→	→
Art.-Nr: 13551	UVP in €: 45,50							



Foto: K. Schlegel



Foto: K. Schlegel

Reisezugwagenset der SBB, bestehend aus zwei Doppelstockwagen 2. Klasse, B-HVZ / Passenger coach set of the SBB with two different 2nd class double-deck coaches B-HVZ

NEU	VI	448	⊕	⊕	Rmin	⊕	⊕	⊕
	NEM	→	→	→	310	→	→	→
Art.-Nr: 01666	UVP in €: 99,90							



Foto: K. Schlegel

Doppelstockwagen 1./2. Klasse, AB-HVZ, der SBB  
1st/2nd class double-deck coach AB-HVZ of the SBB

NEU	VI	223	⊕	⊕	Rmin	⊕	⊕	⊕
	NEM	→	→	→	310	→	→	→
Art.-Nr: 13807	UVP in €: 51,50							



Schwenkdachwagen Tds der Centravo - GZM, eingestellt bei den SBB  
Swing roof car Tds Centravo - GZM of the SBB

NEU	VI	81	■-□-□-□
Art.-Nr: 14579	NEM	← →	NEM
UVP in €: 34,50			



Staubbehälterwagen „Tela Recycling“, eingestellt bei den SBB  
Silo car „Tela Recycling“ of the SBB

	VI	159	■-□-□-□
Art.-Nr: 15489	NEM	← →	NEM
UVP in €: 42,90			



Reisezugwagen 1. Klasse Az der FS  
1st class passenger coach Az of the FS

NEU	IV	220	■-□-□-□
Art.-Nr: 13538	NEM	← →	NEM
UVP in €: 45,50			



Reisezugwagen 2. Klasse Bz der FS  
2nd class passenger coach Bz of the FS

	IV	220	■-□-□-□
Art.-Nr: 13552	NEM	← →	NEM
UVP in €: 45,50			



Offener Güterwagen Tw der SNCF  
Open freight car Tw of the SNCF

NEU	III	76	■-□-□-□
Art.-Nr: 17247	NEM	← →	NEM
UVP in €: 17,90			



Offener Güterwagen Eaos der SNCF, „SGW“  
Open freight car Eaos „SGW“ of the SNCF

NEU	IV	117	■-□-□-□
Art.-Nr: 15258	NEM	← →	NEM
UVP in €: 31,90			

- Mit geänderter Betriebsnummer / Ausführung mit gegossener Drehgestellbauart

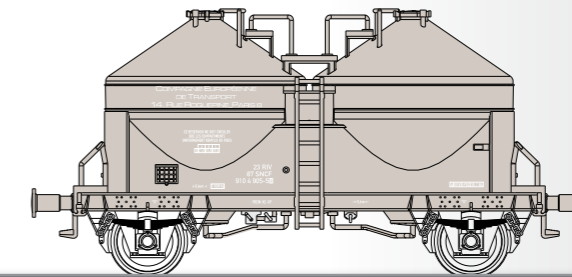
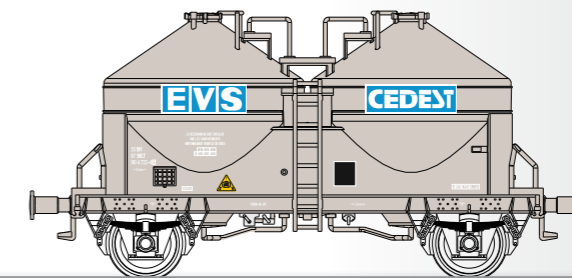

Güterwagenset der SNCF, bestehend aus drei verschiedenen Staubsilowagen  
Freight car set of the SNCF with three different silo cars

CAD Zeichnungen

NEU	IV	214	■-□-□-□
Art.-Nr: 01681	NEM	← →	NEM
UVP in €: 94,90			



Lieferung mit anderer Drehgestell-Bauart  
Niederbordwagen Res der SNCF, beladen mit Rohren  
Low side car Res of the SNCF with load

NEU	VI	166	■-□-□-□
Art.-Nr: 18104	NEM	← →	NEM
UVP in €: 37,90			



Kesselwagen der MILLET S.A.  
Tank car of the MILLET S.A.

NEU	VI	120	□	□	□	□
	NEM	→	→	→	→	→
Art.-Nr: 15474	UVP in €: 40,50					



Säurekesselwagen „SOLVAY“ der RENFE  
Tank car „SOLVAY“ of the RENFE

NEU	V	120	□	□	□	□
	NEM	→	→	→	→	→
Art.-Nr: 15432	UVP in €: 37,90					

Handmuster



Schiebeplanenwagen „EuroLuxCargo“  
Sliding cover box car „EuroLuxCargo“

NEU	V-VI	166	□	□	□	□
	NEM	→	→	→	→	→
Art.-Nr: 15747	UVP in €: 34,50					



Offener Güterwagen der SNCB  
Open freight car of the SNCB

NEU	III	76	□	□	□	□
	NEM	→	→	→	→	→
Art.-Nr: 17248	UVP in €: 17,50					



Reisezugwagen 1. Klasse Am der SNCB  
1st class passenger coach, type Am, of the SNCB

IV	220	□	□	□	□	□
NEM	→	→	→	→	→	→
Art.-Nr: 13537	UVP in €: 45,50					

- Bauart „Eurofima“, passend für EuroCity-Züge / „Eurofima“ type, for EuroCity trains



Reisezugwagen 2. Klasse Bm der SNCB  
2nd class passenger coach, type Bm, of the SNCB

IV	220	□	□	□	□	□
NEM	→	→	→	→	→	→
Art.-Nr: 13554	UVP in €: 45,50					

- Bauart „Eurofima“, passend für EuroCity-Züge / „Eurofima“ type, for EuroCity trains



Diesellokomotive Reihe 52 (NoHAB) der SNCB  
Diesel locomotive (NoHAB) of the SNCB

V	158	□	□	□	□	□
NEM	→	→	→	→	→	→
Art.-Nr: 04531 A	UVP in €: 159,90					

- Überarbeitung: Warm-weiße LED und neuer Motor/with warm-white LED and new motor



Elektrolokomotive Reihe 28 der SNCB  
Electric locomotive 28 of the SNCB

VI	158	□	□	□	□	□
NEM	→	→	→	→	→	→
Art.-Nr: 04906	UVP in €: 178,50					

- Fernlicht schaltbar mit Decoder Art. 66023 / Main beam can be switched on by decoder item-no. 66023



Niederbordwagen Rens der SNCB, beladen mit Spundwänden  
Low side car Rens of the SNCB with load

NEU	VI 166	■-□-□-□-□
Art.-Nr: 18100	UVP in €: 35,90	



Rungenwagen Rs der DSB, beladen mit Rohren  
Stake side car Rs of the DSB loaded with tubes as cargo

IV 166	■-□-□-□-□
Art.-Nr: 15585 A	UVP in €: 35,50

- Abnehmbare, drehbare Rungen / changeable stakes that can be rotated



Kühlwagen IKI der DSB  
Refrigerator car IKI of the DSB

III 91	■-□-□-□-□
Art.-Nr: 14109	UVP in €: 25,50



Kesselwagen Zkk der NYNÄS, eingestellt bei der SJ  
Tank car Zkk NYNÄS of the SJ

NEU	IV 92	■-□-□-□-□
Art.-Nr: 14998	UVP in €: 33,90	

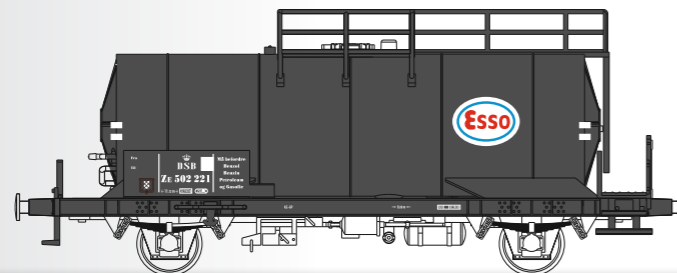

Kesselwagen der Dansk ESSO, eingestellt bei der DSB  
Tank car Dansk ESSO of the DSB

NEU	CAD-Zeichnung	III 92	■-□-□-□-□
Art.-Nr: 17400	UVP in €: 33,90		



Schiebewandwagen Habis Skandiatransport, eingestellt bei der SJ  
Sliding cover box car Habis Skandiatransport of the SJ

NEU	IV 194	■-□-□-□-□
Art.-Nr: 15805	UVP in €: 39,90	



Kesselwagen der „Jansen Benzin“, eingestellt bei der DSB  
Tank car „Jansen Benzin“ of the DSB

NEU	III 74	■-□-□-□-□
Art.-Nr: 95837	UVP in €: 28,50	



Schwenkdachwagen Tds der EEWS  
Swing roof car Rds of the EEWS

NEU	VI 81	■-□-□-□-□
Art.-Nr: 14578	UVP in €: 34,50	

# Unsere START-Modelle für alle kleinen TT-Eisenbahnfreunde



© eyerroom1001 - Fotolia.com

Art.: 04598 und 02709:  
Ausgestattet mit Beleuchtung/With lightning

START-Diesellokomotive BR 203  
„Bahnbau“ der DB AG  
START-Diesel locomotive class 203  
„Bahnbau“ of the DB AG

Art.-Nr: 04598  
UVP in €: 93,50



Speisewagen „MITROPA“ der DR  
Dining car „MITROPA“ of the DR

Art.-Nr: 13239  
UVP in €: 15,50



Personenwagen der DR  
Passenger coach of the DR

Art.-Nr: 13228  
UVP in €: 15,50



START-Diesellokomotive BR 218  
in „InterCity“-Lackierung  
„START“-Diesel locomotive class 218  
in colouring of „InterCity“

Art.-Nr: 02709  
UVP in €: 88,90



Reisezugwagen 1. Klasse der DB AG,  
in „InterCity“-Lackierung  
1st class passenger coach of the DB AG,  
in colouring of „InterCity“

Art.-Nr: 13625  
UVP in €: 17,90



Reisezugwagen 2. Klasse der DB AG,  
in „InterCity“-Lackierung  
2nd class passenger coach of the DB AG,  
in colouring of „InterCity“

Art.-Nr: 13626  
UVP in €: 17,90



Reisezugwagen BD der DB AG,  
in „InterCity“-Lackierung  
Passenger coach BD of the DB AG,  
in colouring of „InterCity“

Art.-Nr: 13609  
UVP in €: 17,90



Speisewagen „Bord Bistro“ in  
„InterCity“-Lackierung/Dining car  
„Bord Bistro“ in colouring of „InterCity“

Art.-Nr: 13759  
UVP in €: 16,50



Niederbordwagen mit Plane „Holzwolle“  
Low side car with tarpaulin

Art.-Nr: 14649  
UVP in €: 11,50

• Mit abnehmbarer Plane/With a tarpaulin sheet that can be removed



Kühlwagen „Interfrigo“  
Refrigerator car „Interfrigo“

Art.-Nr: 14148  
UVP in €: 11,50



Offener Güterwagen „Schüttgut-Verkehr“  
Open car „Schüttgut-Verkehr“

Art.-Nr: 14269  
UVP in €: 10,90



Gedeckter Güterwagen „Expressgut“  
Freight car for transport of parcel

Art.-Nr: 14117  
UVP in €: 11,50





**Gleiserweiterungs-Set „Bahnhof“**  
bestehend aus:

Track extension set „train station“  
consisting of:

- 1 Handweiche, rechts (83816) mit Ausgleichsstück (83722)
- 1 Handweiche, links (83817) mit Ausgleichsstück (83721)
- 7 geraden Gleisen (83701)
- 1 geraden Gleis (83705)
- 1 geraden Gleis (83703)
- 4 geraden Gleisen (83704)
- 2 gebogenen Gleisen (83707)
- 4 Isolierschienenverbindern (83952)
- 2 Schienenverbindern mit Anschlusselement (83951)
- Bedienungsanleitung mit Gleis- und Anschlussplan

- 1 BW, right (83816) with hand drive and compatible unit (83722)
- 1 BW, left (83817) with hand drive and compatible unit (83721)
- 7 straight tracks (83701)
- 1 straight track (83705)
- 1 straight track (83703)
- 4 straight tracks (83704)
- 2 curved tracks (83707)
- 4 Isolated rail joiners (83952)
- 2 rail joiners with connecting element (83951)
- manual with track and wiring diagramm

Art.-Nr: 01833  
UVP in €: 53,90

Mit diesem Set lässt sich das Gleisoval der Sets, Art.-Nr.: 01424 und 01428 auf ein Oval mit zweigleisigem Bahnhof ausbauen. Im Falle der Nutzung abschaltbarer Gleisabschnitte werden zusätzlich ein Tastenpult (Art. 08211) sowie Schaltlitze (Art. 08972) benötigt.

You can build the circular line of the set, item-no.: 01424 and 01428 on an oval track with a railway station with two lines with this set. If you use track sections that can be disconnected a railway push button panel (item-no. 08211) as well as a stranded wire (item-no. 08972) are required.

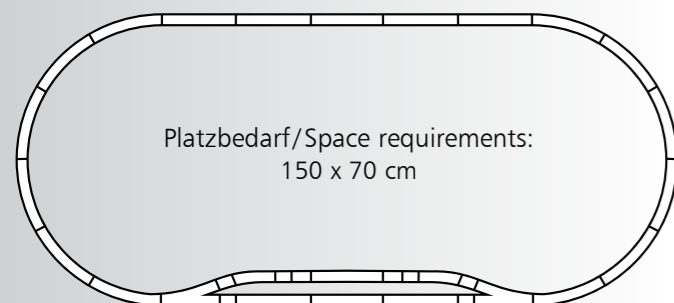

**Zusätzliche Gleiserweiterungs-Sets zum Ausbau der Einsteiger-Sets**  
More track extension sets for the expansion of the beginner sets

**Gleiserweiterungs-Set „Parallelkreis Teil 1“:**  
Track extension set „parallel circuit part 1“:

- 1 Innenbogenweiche, rechts (83861) mit Ausgleichsstück (83726) / 1 curved points, right (83861) with curved compatible unit, left (83726)
- 1 Innenbogenweiche, links (83862) mit Ausgleichsstück (83725) / 1 curved points, left (83862) with curved compatible unit, right (83725)
- 4 gebogene Gleise (83706) / 4 curved tracks (83706)
- 4 gerade Gleise (83701) / 4 straight tracks (83701)
- 2 gerade Gleise (83704) / 2 straight tracks (83704)
- 1 gerades Gleis (83702) / 1 straight track (83702)

Art.-Nr: 01834  
UVP in €: 52,90



**Gleiserweiterungs-Set „Parallelkreis Teil 2“:**  
Track extension set „parallel circuit part 2“:

- 1 Innenbogenweiche, rechts (83861) mit Ausgleichsstück (83726) / 1 curved points, right (83861) with curved compatible unit, left (83726)
- 1 Innenbogenweiche, links (83862) mit Ausgleichsstück (83725) / 1 curved points, left (83862) with curved compatible unit, right (83725)
- 4 gebogene Gleise (83706) / 4 curved tracks (83706)
- 5 gerade Gleise (83701) / 5 straight tracks (83701)
- 4 gerade Gleise (83705) / 4 straight tracks (83705)

Art.-Nr: 01835  
UVP in €: 55,90



**Gleiserweiterungs-Set „Rangierbahnhof“:**  
Track extension set „railroad shunting yard“:

- 2 Handweichen, rechts (83816) mit Ausgleichsstück (83722) / 2 BW, right (83816) with hand drive and compatible unit (83722)
- 1 Handweiche, links (83817) mit Ausgleichsstück (83721) / 1 BW, left (83817) with hand drive and compatible unit (83721)
- 5 gerade Gleise (83701) / 5 straight tracks (83701)
- 1 gerades Gleis (83702) / 1 straight track (83702)
- 1 gerades Gleise (83705) / 1 straight track (83705)
- 3 Prellböcke mit Gleisstück (83700) / 3 buffer stops with track (83700)

Art.-Nr: 01836  
UVP in €: 65,90



**Elektrifizierungs-Set:**  
Electrification set:

- 9 Weichenantriebe (83960) / 9 electric point mechanism (83960)
- 3 Tastenpulte (08211) / 3 control desks (08211)
- 1 Schaltlitze (08972) / 1 stranded hook-up wire (08972)

Art.-Nr: 01837  
UVP in €: 141,50

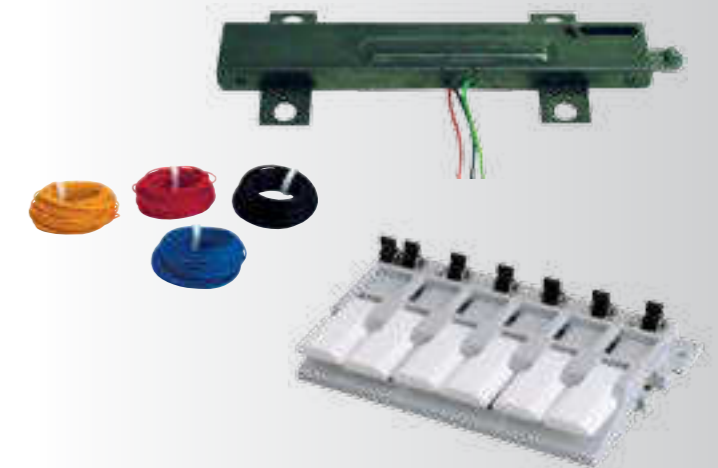



Güterzug-Set der DB AG, bestehend aus/  
Freight car set of the DB AG with:

Lok		Lok	
Art.-Nr: 01424	UVP in €: 137,50		

- Diesellokomotive „TRAXX“ BR 285 mit zwei Güterwagen / Diesel locomotive „TRAXX“ class 285 with two freight cars
- Bettungsgleisoval, TILLIG-Fahrregler (ohne Zubehörausgang) / Bedding track, TILLIG-Controller (without accessory output)
- Container, Straßenfahrzeug, Aufgleiser, Handentkuppler / container, road vehicle, railer, manual uncoupler

**Zusätzlich enthalten unsere Einsteiger-Sets 01424, 01428, 01431 und 01432:**

- Einen 10,- € Gutschein für den Kauf eines Gleiserweiterungssets (01833 ff.)
- 1 Eintrittskarte für das TILLIG-Museum
- 1 coupon of 10,- € for buing of the TILLIG-track-set item.-no. 01833 ff.
- 1 coupon for free entrance at the TILLIG-Museum



Set: 01428

Güterzug-Set bestehend aus/  
Freight car set with:

Lok		Lok	
Art.-Nr: 01428 A	UVP in €: 137,50		

- Diesellokomotive „TRAXX“ BR 285 mit zwei Güterwagen / Diesel locomotive „TRAXX“ class 285 with two freight cars
- Bettungsgleisoval, TILLIG-Fahrregler (ohne Zubehörausgang) / Bedding track, new TILLIG-Controller (without accessory output)
- Container, Straßenfahrzeug, Aufgleiser, Handentkuppler / container, road vehicle, railer, manual uncoupler



Einsteiger-Set: Güterzug der ČD, bestehend aus /  
Beginner set of the ČD with:

Lok		Lok	
Art.-Nr: 01431	UVP in €: 137,50		

- Diesellokomotive „TRAXX“ mit zwei Güterwagen / Diesel locomotive „TRAXX“ and two freight cars
- Bettungsgleisoval, TILLIG-Fahrregler (ohne Zubehörausgang) / Bedding track, TILLIG-Controller (without accessory output)
- Container, Straßenfahrzeug, Aufgleiser, Handentkuppler / container, road vehicle, railer, manual uncoupler

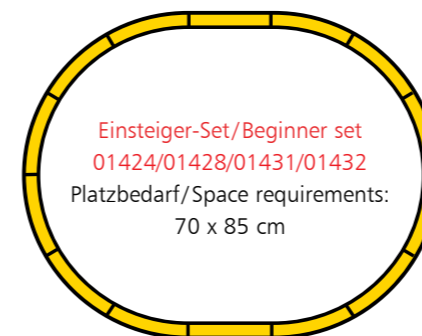

**Hinweis / Note:**  
Alle Einsteiger-Sets enthalten den TILLIG-Fahrregler!  
Das Auto und der Container können je nach Set variieren.  
All sets are equipped with the TILLIG-Controller!  
The road vehicle and the container can be various.



Set 01432

Einsteiger-Set: Güterzug der PKP, bestehend aus /  
Beginner set of the PKP with:

Lok		Lok	
Art.-Nr: 01432	UVP in €: 137,50		

- Diesellokomotive „TRAXX“ mit zwei Güterwagen / Diesel locomotive „TRAXX“ and two freight cars
- Bettungsgleisoval, TILLIG-Fahrregler (ohne Zubehörausgang) / Bedding track, new TILLIG-Controller (without accessory output)
- Container, Straßenfahrzeug, Aufgleiser, Handentkuppler / container, road vehicle, railer, manual uncoupler



**Einsteiger-Set: Güterzug der SBB, bestehend aus**  
Beginner set of the SBB with:

- Diesellokomotive „TRAXX“ BR 285 mit zwei Güterwagen / Diesel locomotive „TRAXX“ class 285 with two freight cars
- Bettungsgleisoval, TILLIG-Fahrregler (ohne Zubehörausgang) / Bedding track, new TILLIG-Controller (without accessory output)
- Container, Straßenfahrzeug, Aufgleiser, Handentkupppler / container, road vehicle, rerailer, manual uncoupler

**Zusätzlich enthält unser Einsteiger-Set:**

- Einen 10,- € Gutschein, einlösbar beim Kauf eines Gleiserweiterungssets (01833-1837)
- 1 Eintrittskarte für das TILLIG-Museum
- 1 coupon of 10,- € for buying of the TILLIG-track-set item.-no. 01833-1837
- 1 coupon for free entrance at the TILLIG-Museum



NEU	VI	522	Lok	
	NEM	→	Plux12	NEM
Art.-Nr: 01434		UVP in €: 137,50		

START-Set 01434  
Platzbedarf / Space requirements:  
70 x 85 cm

Inklusive neuem  
TILLIG-Fahrregler!

**Zusätzlich enthält unser Einsteiger-Set:**

- Einen 10,- € Gutschein für den Kauf eines Gleiserweiterungssets (01833 ff.)
- 1 Eintrittskarte für das TILLIG-Museum
- 1 coupon of 10,- € for buying of the TILLIG-track-set item.-no. 01833 ff.
- 1 coupon for free entrance at the TILLIG-Museum

START-Set 01429  
Platzbedarf / Space require-  
ments: 70 x 85 cm



Set 01429



Inklusive  
TILLIG-Fahrregler!



**Einsteiger-Set: Güterzug der SNCF, bestehend aus /**  
Beginner set of the SNCF with:

- Diesellokomotive „TRAXX“ Reihe 076 mit zwei Güterwagen (Güterwagen werden nach französischem Vorbild erscheinen)  
Diesel locomotive „TRAXX“ class 076 with two freight cars
- Bettungsgleisoval, TILLIG-Fahrregler (ohne Zubehörausgang) / Bedding track, TILLIG-Controller (without accessory output)
- Container, Straßenfahrzeug, Aufgleiser, Handentkupppler / container, road vehicle, rerailer, manual uncoupler

VI	522	Lok		Lok
NEM	→	Plux12	NEM	Plux12
Art.-Nr: 01429 A		UVP in €: 137,50		

Zusätzlich enthalten unsere Einsteiger-Sets 01425 und 01426:

- 1 Eintrittskarte für das TILLIG-Museum
- 1 coupon for free entrance at the TILLIG-Museum



Beide Sets inklusive TILLIG-Fahrregler!



Personenzug-Set der DR, bestehend aus/  
Passenger coach set of the DR with:

- Diesellokomotive BR 110 mit zwei E5-Wagen/Diesel locomotive class 110 with two passenger coaches E5
- Modellgleisoval mit Abstellgleis, neuer TILLIG-Fahrregler (ohne Zubehörausgang)/ Advanced-track-oval with siding, new TILLIG-Controller (without accessory output)
- Straßenfahrzeug, Aufgleiser, Handentkuppler/road vehicle, reailer, manual uncoupler

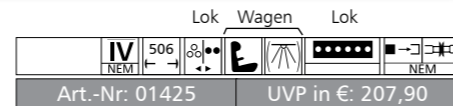

Set 01425



Personenzug-Set der DB, bestehend aus/  
Passenger coach set of the DB with:

- Diesellokomotive V 80 mit drei Personenwagen/  
Diesel locomotive class V 80 with three passenger coaches
- Modellgleisoval mit Abstellgleis, neuer TILLIG-Fahrregler (ohne Zubehörausgang)/ Advanced-track-oval with siding, new TILLIG-Controller (without accessory output)
- Straßenfahrzeug, Aufgleiser, Handentkuppler/road vehicle, reailer, manual uncoupler

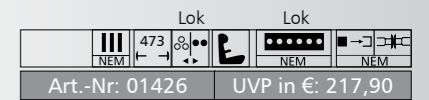

Set 01426

Straßenfahrzeuge / Vehicles



Trabant 601 Kombi „Deutsche Reichsbahn“  
Trabant 601 estate car „Deutsche Reichsbahn“

Art.-Nr: 08737 UVP in €: 7,90



Trabant 601 Kombi „Deutsche Post“  
Trabant 601 estate car „Deutsche Post“

Art.-Nr: 08730 A UVP in €: 7,90



Trabant 601 Kombi „Deutsche Post“  
Trabant 601 estate car „Deutsche Post“

Art.-Nr: 08734 A UVP in €: 7,90



Trabant 601 Kombi  
Trabant 601 estate car  
• Zweifarbig / bicolour

Art.-Nr: 08736 A UVP in €: 7,90



Trabant 601 Kombi „VEB Energieversorgung“  
Trabant 601 estate car „VEB Energieversorgung“

Art.-Nr: 08738 UVP in €: 7,90



Trabant 601 Kombi  
Trabant 601 estate car  
• Zweifarbig / bicolour

Art.-Nr: 08739 UVP in €: 7,90



Wartburg 353 „DRK“  
Wartburg 353 „DRK“

Art.-Nr: 08691 UVP in €: 9,90



Wartburg 353 „Feuerwehr“  
Wartburg 353 „Feuerwehr“

Art.-Nr: 08690 UVP in €: 9,90



Wartburg 353 „Polizei“  
Wartburg 353 „police“

Art.-Nr: 08678 A UVP in €: 9,90



Handmuster

Wartburg 353 de Luxe  
Wartburg 353 deLuxe

Art.-Nr.: 08692 UVP in €: 9,90



Wartburg 353 de Luxe  
Wartburg 353 deLuxe

Art.-Nr: 08689 A UVP in €: 9,90



Handmuster

Matador Kastenwagen  
Matador van „Landmaschinenhandel Schepperle“

Art.-Nr: 08608 UVP in €: 11,50



Matador Kastenwagen „Deutsche Bundespost“  
Matador van „Deutsche Bundespost“

NEU / NEW

Art.-Nr: 08609 UVP in €: 11,50



Matador Kastenwagen „Deutsche Bundesbahn“  
Matador van „Deutsche Bundesbahn“

Art.-Nr: 08632 UVP in €: 11,50



Matador Kastenwagen „DEA Pumpendienst“  
Matador van „DEA Pumpendienst“

Art.-Nr.: 08631A UVP in €: 11,50



Handmuster

Matador Kastenwagen „Lindt“  
Matador van „Lindt“

NEU / NEW

Art.-Nr.: 08634 UVP in €: 11,50



Matador Kastenwagen „Molkerei Sauer“  
Matador van „Molkerei Sauer“

Art.-Nr.: 08633 UVP in €: 11,50



LKW H3A Tankwagen „DRK“  
Tank truck H3A „DRK“

Art.-Nr.: 08798 UVP in €: 15,50



LKW H3A „VEB Kraftverkehr Eisenach“, beladen mit Rollgutbehälter  
Truck H3A „VEB Güterkraftverkehr Eisenach with load

Art.-Nr: 08795 UVP in €: 15,50



Lkw H3A „Wernesgrüner“  
Truck H3A „Wernesgrüner“

Art.-Nr: 08794 A UVP in €: 13,90



LKW H3A „DRK“  
Truck H3A „DRK“

Art.-Nr: 08792 A UVP in €: 13,90



LKW H3A „Deutsche Post“  
Truck H3A „Deutsche Post“

Art.-Nr: 08793 A UVP in €: 13,90



LKW H3A „VEB Leuna“  
Tank truck H3A „VEB Leuna“

Art.-Nr.: 08796 UVP in €: 13,90



LKW H3A Tankwagen „LEUNA-LEIME“  
Tank truck H3A „LEUNA LEIME“

NEU / NEW

Art.-Nr: 08797 UVP in €: 15,50



LKW H3A „VEB Energieversorgung“, beladen mit Kisten  
Truck H3A „VEB Energieversorgung“ with load

NEU / NEW

Art.-Nr.: 19001 UVP in €: 15,50



LKW H3A „VEB Lockwitzgrund“  
Truck H3A „VEB Lockwitzgrund“

NEU / NEW

Art.-Nr.: 19002 UVP in €: 15,50



LKW Robur LO 1801  
Kofferaufbau; „Deutsche Post“ / Truck Robur LO 1801 „Deutsche Post“

NEU / NEW

Art.-Nr.: 19020 UVP in €: 17,50



LKW H3A und Anhänger „VEB Güterkraftverkehr Dresden“ / Truck H3A and H3A truck trailer „VEB Güterkraftverkehr Dresden“

Art.-Nr: 08636 A UVP in €: 25,90



LKW MAN mit Containeraufleger und zwei Containern  
Truck MAN with semi-trailer loaded with two containers

Art.-Nr: 08712 UVP in €: 25,90



LKW RABA mit Pritschenaufleger „ČSAD“  
Truck RABA with semi-trailer „ČSAD“

Art.-Nr: 08711 A UVP in €: 25,90



LKW Roman mit Containeraufleger beladen mit zwei Containern / Truck Roman with semi-trailer loaded with two containers

Art.-Nr.: 501137 UVP in €: 25,90



Set mit zwei Panzern T 34/85  
Set with two tanks T34/85

• Ohne Bedruckung für universellen Einsatz / Without printing, for universal application

NEU / NEW

Art.-Nr: 07745 UVP in €: 20,50



Set mit zwei Schützenpanzern BMP-1  
Set with two tanks BMP-1

• Ohne Bedruckung für universellen Einsatz / Without printing, for universal application

Art.-Nr: 07745 UVP in €: 20,50



Container-Set mit drei 20“ Containern  
Container set 20“ container

Art.-Nr: 07708  
UVP in €: 9,50  
NEU / NEW



## Digitale Steuerung des Anlagenbetriebes

### Vorteile der digitalen Steuerung:

- Mehrere Triebfahrzeuge sind unabhängig voneinander auf dem selben Stromkreis steuerbar. So lassen sich vorbildentsprechende Betriebssituationen wesentlich einfacher nachbilden als mit analoger Steuerung.
- Die digitale Steuerung benötigt für gleichzeitigen Fahrbetrieb mehrerer Züge keine Unterteilung der Anlage in verschiedene Stromkreise.
- Bessere Fahreigenschaften als im konventionellen Betrieb: Hervorragende Langsamfahreigenschaften, konstante Geschwindigkeiten unabhängig von der Zuglast durch lastgeregelter Decoder
- Simulation einer Anfahr- und Bremsbeschleunigung
- Konstante Zugbeleuchtung
- Zusatzfunktionen wie Licht oder Sound sind getrennt voneinander und funktionieren auch im Stand
- Verringerter Verdrahtungsaufwand durch digitale Ansteuerung der Zubehördecoder

### Prinzip der Digitalsteuerung:

- Steuerung basiert auf einem „intelligenten“ Fahrregler (Zentrale)
- Als „Übersetzer“ der Signale der Zentrale zur Lok dient ein Decoder, der in die Lok eingebaut wird
- Am Gleis liegt ständig eine konstante Spannung an (im Gegensatz zum konventionellen Analogbetrieb, wo die Geschwindigkeit mit der Höhe der Spannung geregelt wird)
- Für die Erteilung von Fahrbefehlen durch die Zentrale erhält jede Lok eine „Adresse“.

- Die Lok reagiert nur auf Befehle der Zentrale, wenn diese auf die Adresse der Lok bezogen sind. Zu den Befehlen zählen z. B.: Regelung der Geschwindigkeit, Wahl der Fahrtrichtung, Schalten von Licht- und Soundfunktionen
- Es können mehrere Loks auf demselben Gleis unterschiedliche Fahrzustände – unabhängig voneinander – einnehmen
- Die Decoder können in ihren Eigenschaften eingestellt werden (Programmieren) z. B. Adresse der Lok, Anfahr- und Bremsverzögerung

### Das Digitalsystem bei TILLIG:

TILLIG liefert im Herbst 2014 das neue Digital-System in Kooperation mit der Firma Uhlenbrock. Auf der S. 188 erhalten Sie zu unseren neuen Digital-Einsteigersets diverse Detailinformationen. Diese Sets enthalten dann auch die neuen Digitalkomponenten der Fa. Uhlenbrock.

### Hinweis zur Umrüstung konventioneller Triebfahrzeuge auf Digitalbetrieb:

Diese erfolgt durch Mini-Decoder (siehe S. 189), die auch in älteren und kleineren TT-Lokomotiven verwendet werden können. Für weniger handwerklich begabte Modellbahner bietet die Firma TILLIG die Ausrüstung der ehemaligen TILLIG Modelle ab Baujahr 1995 und der Modelle aus eigener Produktion mit Decodern an. Auf Wunsch können alle Loks (Ausnahme E 44) ab Werk digitalisiert werden. Bitte dies bei Ihrer Bestellung im Fachhandel angeben!

## Digitalization of model railway system operation

### Advantages of digital control:

- Several power units can be controlled independent from each other. So you can imitate realistic operating situations better than an analogue control.
- With digital control it is not necessary to divide the set into several track sections for traction operations of several trains at the same time.
- Better driving characteristics than in conventional operation: excellent characteristics in driving slowly, with the decoder you have a constant speed independent of load.
- Simulation of starting and braking acceleration
- Constant train lighting
- Additional functions like light and sound are separate and even works in stop
- Less work for wiring because activation of decoder for additional parts occurs by the track

### Principle of digital control

- Control is based on an „intelligent“ controller
- A decoder integrated in the locomotive is „translating“ the signals from control centre to the locomotive
- On the track a constantly voltage is still applied (in contrast to conventionally analogue operation where speed is controlled by voltage)

- Each locomotive has got an address to get propulsion command from control centre
- The locomotive only responds to instructions from control centre which refers to their address. These are instructions like controlling speed, to choose driving direction, to switch light and sound functions)
- Several locomotives on the same track can have different driving conditions – independently from each other
- The decoders can be programmed e.g. the address of the locomotive, starting / braking delay to simulate the loads of the train

### The digital system of TILLIG:

TILLIG will deliver in autumn 2014 the new digital system in cooperation with the firm Uhlenbrock. On page 188 you got various informations about our new digital beginner sets. These sets will also include the new digital components from the firm Uhlenbrock.

### Tip to convert conventional power units to digital operation:

The conversion is made by mounting Mini-Decoder (page 189) which can also be used in older and smaller TT-locomotives. TILLIG offers you to convert former ZEUGE / BTTB models and models from our own production with decoders. On request all locomotives (excepting E 44) are available digital equipped. Please quote when ordering at your speciality retailer.



**DIGITAL**



Handmuster

**Digital-Einsteiger-Set: Güterzug der DR, bestehend aus / Digital beginner set of the DR with:**

- Diesellokomotive BR 110 mit Digital-Decoder und vier verschiedenen Wagen / Diesel locomotive class 110 with digital-decoder and four different cars

NEU	IV	480	Lok	Lok
			NEM	NEM
Art.-Nr: 01208		UVP in €: 369,00		

Beide Sets enthalten / both sets consisting of:

- Digitalgrundausrüstung in Kooperation mit Uhlenbrock Elektronik GmbH: Zentraleinheit mit Verstärker, Handregler, Stromversorgung (Netzteil) / digital assecoires in cooperation with Uhlenbrock Elektronik GmbH: command station, manual control, AC adapter
- Modellgleisoval mit Abstellgleis (70 x 100 cm), elektrischer Weichenantrieb / Advanced-track-oval with siding (70 x 100 cm), electric operating gear
- Straßenfahrzeug, Aufgleiser, Handentkuppler / road vehicle, re-railer, manual uncoupler



Set 01207

**Digital-Einsteiger-Set: Güterzug der DB, bestehend aus / Digital beginner set of the DB with:**

- Diesellokomotive V 80 mit Digital-Decoder und vier verschiedenen Wagen / Diesel locomotive class V 80 with digital-decoder and four different cars

NEU	III	469	Lok	Lok
			NEM	NEM
Art.-Nr: 01207		UVP in €: 369,00		

Verwendung der verschiedenen Decodertypen in TILLIG-Fahrzeugen/Use of the various decoder types in TILLIG vehicles

- x ... Empfohlener Einsatz des Decoders/Recommended use of the decoder
- o ... Einsatz des Decoders möglich, aber nicht Nutzung aller Funktionen möglich/Use of the decoder is possible but the use of all functions is not possible

	Loks mit 6-poliger Schnittstelle zum Löten Locomotives with 6 pole interface for soldering	Loks mit 6-poliger Steck-Schnittstelle Locomotives with 6 pole insertion interface	Fahrzeuge mit 6-poliger Steck-Schnittstelle und zusätzlichen Anschlüssen zum Löten Vehicles with 6 pole insertion interface and additional connections for soldering	Loks mit PluX-12 Schnittstelle Locomotives with PluX-12 interface
Symbol/Symbols				
Beispiele/Examples	Diesellok V 100, V36 ältere TILLIG-Loks  Diesel locomotive class V 100 and older TILLIG-Locomotives	Alle Dampfloks aus dem aktuellen TILLIG-Sortiment; V 60, VT 137, E 10.3, E 11/42, E 10.1 All steam locomotives of the actual TILLIG-Program, class V 60, VT 137, E 10.3, E 11/42	E-Lok BR 103 (Ausführungen vor Überarbeitung), Desiro, V 60.0, IC/IR-Steuerwagen Electric locomotive class 103 (previous versions), Desiro, V 60.0, IC/IR-driving cab coach	Überarbeitete Loks mit ehemals Bühler-Motor, BR 107, BR 189, sowie neue Elektro-/Dieselloks All revision locomotives with previous motor „Bühler“, class 107, class 189, new electric and diesel locomotives
66022 Decoder mit Kabel (Uhlenbrock)	x			
66021 Decoder mit Stecker (Uhlenbrock)		x	o	o
66017 DCX74D (CT-Elektronik)			x	o
66016 PluX12-Decoder (TAMS)				nur / only for BR 189
66023 Decoder PluX 12 (Uhlenbrock)				x außer BR 189 bis Baujahr 2013 / excluding BR 198 till year of manufacture 2013



Funktionsdecoder (11 x 8 x 2,4)\*

Art.-Nr: 66020 UVP in €: 27,90

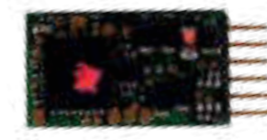

Decoder mit Stecker NEM 651 decoder to connection via plugs (14,9 x 8,6 x 2,4)\*

Art.-Nr: 66021 UVP in €: 27,90

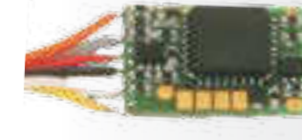

Decoder mit Kabel NEM 651 decoder to connection via soldering (14,9 x 8,6 x 2,4)\*

Art.-Nr: 66022 UVP in €: 28,90

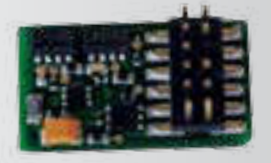

Decoder PluX 12 nach NEM 658 (außer BR 189) PluX12 digital decoder (14,7 x 8,6 x 2,4)\*

Art.-Nr: 66023 UVP in €: 29,90



Kehrsleifenrelais Reverse-loop relays

Art.-Nr: 66120 UVP in €: 19,90



Loconet Verteiler Loconet distributor

Art.-Nr: 66588 UVP in €: 9,60



Schnittstellenstecker 6-polig NEM 651 (5 Stück) für Digitalisierung V36

Art.-Nr: 08914 UVP in €: 17,95

\* Maßangaben (L x B x H) in Millimetern. / Dimensions (l x b x h) in millimeters.

Schnittstelle nach NEM 651, Kontaktbelegung/Interface to NEM 651, contact assignment

Kontakt 1/contact 1: Motoranschluss 1/Engine connection 1	– orange/orange
Kontakt 2/contact 2: Motoranschluss 2/Engine connection 2	– grau/grey
Kontakt 3/contact 3: Stromabnahme, rechts/Electric current, right	– rot/red
Kontakt 4/contact 4: Stromabnahme, links – Masse/Electric current, left – mass	– schwarz/black
Kontakt 5/contact 5: Beleuchtung, vorn/Lighting, front side	– weiß/white
Kontakt 6/contact 6: Beleuchtung, hinten/Lighting, back side	– gelb/yellow

**Hinweis / Note:**

Bei der Diesellok V 100 und älteren TILLIG-Loks kann der Decoder 66022 eingelötet werden, siehe S. 189. / The decoder 66022 can solder in diesel locomotive class V 100 and older TILLIG locomotives, page 189.

Tabelle 1: PIN-Belegung PluX System/PluX System PIN assignment			
PluX12 Pin	Name/Name	Farbe/Colour	Beschreibung/Description
7	F0f	weiß/white	Licht Fahrtrichtung vorwärts/Light when the direction of travel is forwards
8	Motor+	orange/orange	Motoranschluss Plus/Plus motor connection
9	V+	blau/blue	Decoder Plus, Abgriff nach Gleichrichter/Plus decoder, connector to rectifier
10	Motor-	grau/grey	Motoranschluss Minus/Minus motor connection
11	Index		Nicht benutzt, Kodierung/Not used, coding
12	Schiene rechts	rot/red	Schiene rechts in Fahrtrichtung vorwärts/Direction of travel is forwards when on the right track
13	F0r	gelb/yellow	Licht Fahrtrichtung rückwärts/Light when the direction of travel is backwards
14	Schiene links	schwarz/black	Schiene links in Fahrtrichtung vorwärts/Direction of travel is forwards when on the left track
15	LS/A		Lautsprecher Anschluss A/Loudspeaker connection A
16	AUX1	grün/green	Ausgang 1, Zugschlussbeleuchtung in Fahrtrichtung vorwärts Output 1, train rear lighting when direction of travel is forwards
17	LS/B		Lautsprecher Anschluss B/Loudspeaker connection B
18	AUX2	violett/purple	Ausgang 2, Zugschlussbeleuchtung in Fahrtrichtung rückwärts Output 2, train rear lighting when direction of travel is backwards

Erweiterte Funktionen der PluX12-Schnittstelle bei Einsatz eines PluX12-Decoders / Extended functions of the PluX12 interface when using a PluX12-Decoders:



- z. B. je nach Modell
- Rote Schlusslichter separat ausschaltbar
  - Rangierlicht: Spitzenlichter an beiden Seiten zugleich einschaltbar
  - Fernlicht separat schaltbar

- e.g. depending on model
- Red rear lights can be switched off separately
  - Shunting light: Top lights at both sides can be switched on at the same time
  - Long-distance light can be switched separately

Weitere Informationen, auch zum Nachrüsten für Sound, entnehmen Sie bitte der jeweiligen Bedienungsanleitung der einzelnen Lokomotiven.

Please gather further information, also regarding retrofitting for sound, from the respective operating instructions of the individual locomotives.

Kennzeichnung der Indizierung / Identification of indexing

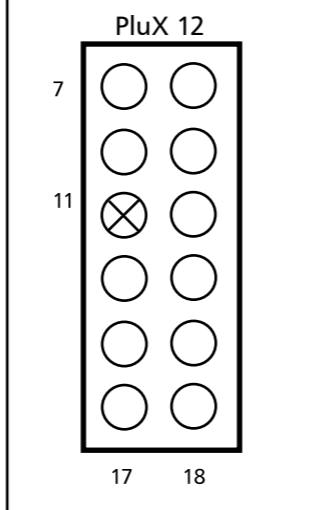

Decoder Gold mini + zum Anschluss über Kabel Gold mini + decoder to connection via soldering (11 x 9 x 2,6)\*

Art.-Nr: 66012 A UVP in €: 50,90



Decoder Gold mini + zum Anschluss über Stecker Gold mini + decoder to connection via plugs (12,5 x 9 x 2,6)\*

Art.-Nr: 66013 A UVP in €: 50,90



Digitaldecoder PluX12, ermöglicht zusätzliche Licht- und Soundfunktionen/PluX12 digital decoder, enables additional light and sound functions (20 x 9,5 x 3,5)\*

Art.-Nr: 66016 A UVP in €: 33,90

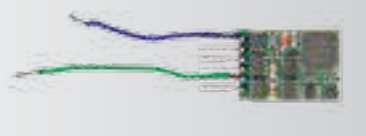

Digitaldecoder CT Elektronik DCX74D, ermöglicht zusätzliche Lichtfunktion/Decoder CT Electronic CX74D, enables additional light functions (13 x 9 x 1,5)\*

Art.-Nr: 66017 UVP in €: 48,90

Decoder Silber mini + zum Anschluss über Kabel Silver mini + decoder to connection via soldering (11,5 x 7,5 x 2,6)\*



Art.-Nr: 66014 A UVP in €: 43,50

\* Maßangaben (L x B x H) in Millimetern. / Dimensions (l x b x h) in millimeters.



Soundbausteine (Lautsprecher und Soundkapsel)/Sound modules (Loudspeakers and sound capsules):



Soundbaustein für BR 189 (Lautsprecher und Soundkapsel), ermöglicht beim Einsatz eines PluX12-Decoders im Digitalbetrieb (Art.-Nr. 66016) die Wiedergabe der Typhontöne der Lok  
Sound module for BR 189 (loudspeaker and sound capsule) enables the reproduction of the locomotive's typhon tones when using a PluX12 decoder in the digital mode (Item no. 66016)

Art.-Nr: 66050 UVP in €: 17,50

Soundbaustein für überarbeitete Dieselloks mit PluX12-Schnittstelle (BR 118, 119, 218, 220, NoHAB), ermöglicht beim Einsatz eines PluX12-Decoders im Digitalbetrieb (Art.-Nr. 66016) die Wiedergabe der Typhontöne der Lok  
Sound module for modified diesel locomotives with PluX12 interface (BR 118, 119, 218, 220, NoHAB) enables the reproduction of the locomotive's typhon tones when using a PluX12 decoder in the digital mode (Item no. 66016)

Art.-Nr: 66051 UVP in €: 17,50



## Unser Bettungs-Gleissystem – Der ideale Einstieg in die Welt der TT-Modelleisenbahn Our bedding track system – The best start into the world of modelrailways

Damit wird Ihnen der Aufbau einer Modellbahnanlage leicht gemacht wie noch nie. Durch das moderne Verbindungssystem „UniJoiner“® vereint es Funktionalität und Optik des bekannten TT-Modellgleises mit einer genial einfachen Montage. Das bereits integrierte Schotterbett gibt den Gleisen ein vorbildentsprechendes Aussehen und lässt z. B. die Weichenantriebe einfach „verschwinden“. Die Geometrie des Bettungsgleises ist so gewählt, dass volle Kompatibilität zum TT-Modellgleis besteht. So kann ganz leicht eine Modellbahnanlage aufgebaut werden – vom einfachen Gleisbild bis zum großzügig gestalteten Fahrbetrieb. Schritt für Schritt werden wir künftig dieses Gleissystem weiter ausbauen, so dass in Zukunft die Möglichkeiten der Gleisplanung noch vielfältiger werden.

With bedding track system the design of model railway is as simple as never before. The modern connector system „UniJoiner“ joins both in functionality and optical characteristics of the known TT-model track with very easy assembling. With the still integrated ballast bed tracks are true to the original and point mechanism seems to disappear. The bedding track geometry is absolutely compatible with TT-model track. So it is easy to design a model railway – from easy track diagram to extensive designed model railway. Step by step we will expand our track system so you get various possibilities for planning tracks.

„UniJoiner“® ist ein Warenzeichen von Kato.  
„UniJoiner“ is a trade mark of Kato.



### Die Vorteile auf einen Blick:

- Kinderleicht, stabil und robust
- Sichere Verbindung der Gleiselemente: Ein „Klick“ – und fertig!
- Weichenantriebe sind nicht sichtbar
- Hervorragend geeignet für Gleisanlagen zum häufigen Auf- und Abbau sowie für Vitrinen
- Einsatz auf jedem Untergrund (Teppich, Tisch usw.) möglich
- Kompatibilität zum Modellgleis (unter Verwendung von Modellgleis-Schienenverbindern; dabei bitte den Höhenausgleich durch entsprechenden Unterbau des Modellgleises beachten)

### Advantages at a glance:

- it is child's play to use, robust
- certain connection between track elements one „click“ – and ready
- point mechanism is invisible
- eminent suited to set up and dismantle tracks often
- can be used for every underground
- compatible with TT-model track (using rail joiner of model track; please note to adapt the difference in height)

Foto: H. Liedtke

Gerade Gleise / Straight track



BG1: Gerades Gleis, 166 mm  
BG1: Straight track, 166 mm

Art.-Nr: 83701	UVP in €: 2,10	
Art.-Nr: 83712	UVP in €: 2,10	NEU braun



BG2: Gerades Gleis, 83 mm  
BG2: Straight track, 83 mm

Art.-Nr: 83702	UVP in €: 2,00	
Art.-Nr: 83713	UVP in €: 2,00	NEU braun

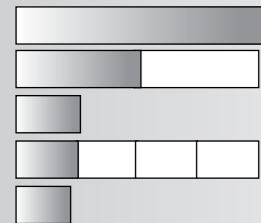

G1 = 166,0 mm  
G2 = 83,0 mm  
G3 = 43,0 mm  
G4 = 41,5 mm  
G5 = 36,5 mm



BG4: Gerades Gleis, 41,5 mm  
BG4: Straight track, 41,5 mm

Art.-Nr: 83703	UVP in €: 1,80	
Art.-Nr: 83715	UVP in €: 1,80	NEU braun

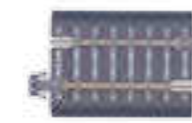

BG3: Gerades Gleis, 43 mm  
BG3: Straight track, 43 mm

Art.-Nr: 83705	UVP in €: 1,90	
Art.-Nr: 83714	UVP in €: 1,90	NEU braun

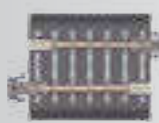

BG5: Gerades Gleis, 36,5 mm  
BG5: Straight track, 36,5 mm

Art.-Nr: 83704	UVP in €: 1,80	
Art.-Nr: 83716	UVP in €: 1,80	NEU braun

Gebogene Gleise / Curved track



BR11: Gebogenes Gleis, R 310 mm/30°  
BR11: Curved track, R 310 mm/30°

Art.-Nr: 83709	UVP in €: 2,60	
Art.-Nr: 83719	UVP in €: 2,60	NEU braun



BR21: Gebogenes Gleis, R 353 mm/30°  
BR21: Curved track, R 353 mm/30°

Art.-Nr: 83706	UVP in €: 2,60	
Art.-Nr: 83717	UVP in €: 2,60	NEU braun



BR12: Gebogenes Gleis, R 310 mm/15°  
BR12: Curved track, R 310 mm/15°

Art.-Nr: 83710	UVP in €: 2,10	
Art.-Nr: 83720	UVP in €: 2,10	NEU braun



BR22: Gebogenes Gleis, R 353 mm/15°  
BR22: Curved track, R 353 mm/15°

Art.-Nr: 83707	UVP in €: 2,10	
Art.-Nr: 83718	UVP in €: 2,10	NEU braun

Kreuzung / Crossing



BK1: Kreuzung, 15°  
BK1: Crossing, 15°

Art.-Nr: 83760	UVP in €: 26,90	
Art.-Nr: 83761	UVP in €: 26,90	NEU braun

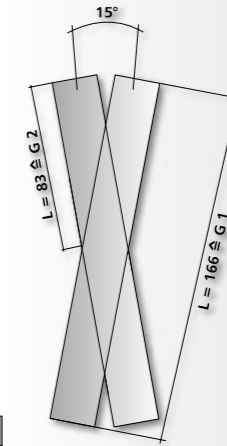

Einfache Weichen  
Straight points

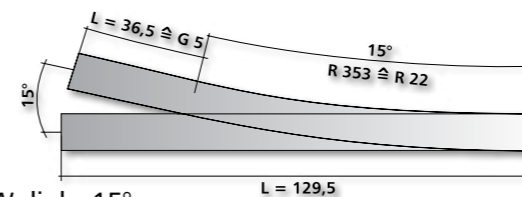

BW, links 15°, mit Handantrieb  
BW, left, 15°, with hand drive

Art.-Nr: 83817	UVP in €: 15,50	
Art.-Nr: 83821	UVP in €: 15,50	NEU braun

BW, rechts 15°, mit Handantrieb  
BW, right, 15°, with hand drive

Art.-Nr: 83816	UVP in €: 15,50	
Art.-Nr: 83820	UVP in €: 15,50	NEU braun

Innenbogenweichen  
Inside curved points

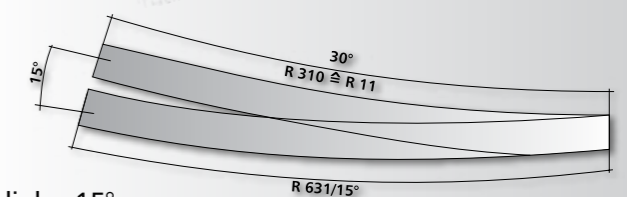
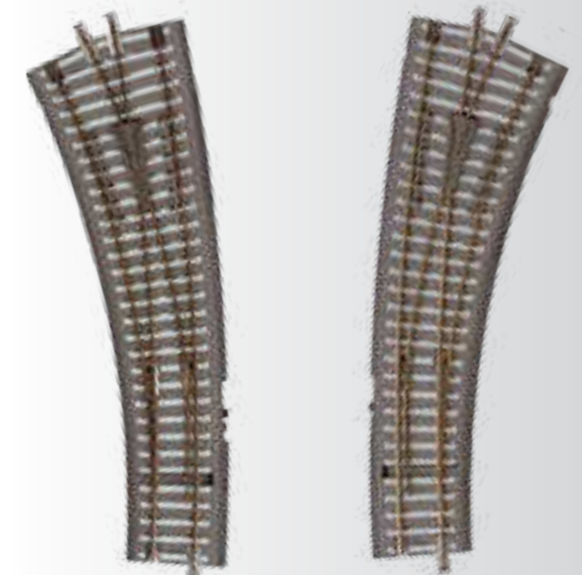

IBW, links 15°, mit Handantrieb  
IBW, left, 15°, with hand drive

Art.-Nr: 83862	UVP in €: 19,70	
Art.-Nr: 83864	UVP in €: 19,70	NEU braun

IBW, rechts 15°, mit Handantrieb  
IBW, right, 15°, with hand drive

Art.-Nr: 83861	UVP in €: 19,70	
Art.-Nr: 83863	UVP in €: 19,70	NEU braun

Pass-Stücke / Compatible units

Die Pass-Stücke haben jeweils eine Aussparung in der Bettung auf der rechten bzw. linken Seite. Ein Pass-Stück wird an einem der beiden abzweigenden Gleise direkt hinter der Weiche benötigt.

The compatible units have a cut-out in bedding on the right/left side. A compatible unit is required at one of the two branched tracks directly behind the points.

Hinweis / Note:

Im Bedarfsfall sind die werksseitig angebrachten Schienenverbinder zu entfernen bzw. umzustecken. / You can remove or change the position of the rail joiners which are mounted by the factory.



BR 12-22kre: Gebogenes Pass-Stück, rechts, R 310 – 353 mm/15°  
BR 12-22kre: Curved compatible unit, right, R 310 – 353 mm/15°

Art.-Nr: 83725	UVP in €: 2,10	
Art.-Nr: 83731	UVP in €: 2,10	NEU braun



BR 22kre: Gebogenes Pass-Stück, rechts, R 353 mm/15°  
BR 22kre: Curved compatible unit, right, R 353 mm/15°

Art.-Nr: 83723	UVP in €: 2,10	
Art.-Nr: 83729	UVP in €: 2,10	NEU braun



BR 22kli: Gebogenes Pass-Stück, links, R 353 mm/15°  
BR 22kli: Curved compatible unit, left, R 353 mm/15°

Art.-Nr: 83724	UVP in €: 2,10	
Art.-Nr: 83730	UVP in €: 2,10	NEU braun



BG 5: Pass-Stück, kre  
BG 5: Compatible unit, kre

Art.-Nr: 83721	UVP in €: 1,20	
Art.-Nr: 83727	UVP in €: 1,20	NEU braun



BG 5: Pass-Stück, kli  
BG 5: Compatible unit, kli

Art.-Nr: 83722	UVP in €: 1,20	
Art.-Nr: 83728	UVP in €: 1,20	NEU braun

BR 12-22kli: Gebogenes Pass-Stück, links, R 310 – 353 mm/15°  
BR 12-22kli: Curved compatible unit, left, R 310 – 353 mm/15°

Art.-Nr: 83726	UVP in €: 2,10	
Art.-Nr: 83732	UVP in €: 2,10	NEU braun



Foto: H. Liedtke

Entkupplungsgleis / Uncoupling track

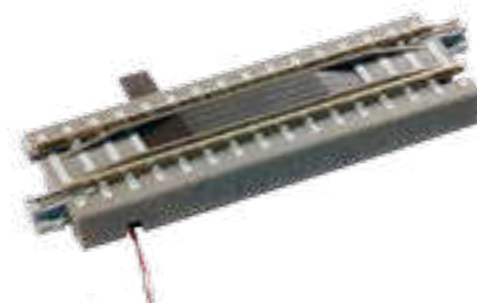

Entkupplungsgleis, 83 mm, elektromotorisch  
Uncoupling track, 83 mm, electromotive

Art.-Nr: 83801	UVP in €: 27,90	
Art.-Nr: 83802	UVP in €: 27,90	NEU braun



Schaltgleis, 83 mm  
(geeignet für Pendelzugsteuerung mit Tfi2)  
Switching track 83 mm  
(for automated shuttle train control by Tfi2)

Art.-Nr: 83758	UVP in €: 9,80	
Art.-Nr: 83759	UVP in €: 9,80	NEU braun

Gleiszubehör / Track accessories

Halbe Schienenverbinder für Bettungsweiche  
Half rail joiners for roadbed points

Art.-Nr: 396942	UVP in €: 0,60	
Art.-Nr: 396943	UVP in €: 0,60	NEU braun

Isolierschienenverbinder (Beutel à 20 Stück)  
Isolated rail joiners (bag of 20)

Art.-Nr: 83952	UVP in €: 3,60	
Art.-Nr: 83955	UVP in €: 0,60	NEU braun

Bettungsgleis-Schienenverbinder (Beutel à 20 Stück)  
Bedding track rail joiners (bag of 20)

Art.-Nr: 83950	UVP in €: 6,60	
Art.-Nr: 83953	UVP in €: 6,60	NEU braun

Schienenverbinder mit Anschlusselement  
(Beutel à 10 Stück)  
Rail joiners with connector

Art.-Nr: 83951	UVP in €: 7,70	
Art.-Nr: 83954	UVP in €: 7,70	NEU braun

Schotterabschluss (Beutel à 4 Stück)  
Gravel terminal (bag of 4)

Art.-Nr: 83961	UVP in €: 3,20	
Art.-Nr: 83963	UVP in €: 3,20	NEU braun

Prellbock mit Gleisstück 43 mm  
Buffer stop with track 43 mm

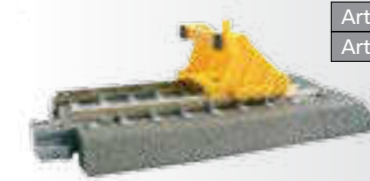

Art.-Nr: 83700	UVP in €: 5,80	
Art.-Nr: 83711	UVP in €: 5,80	NEU braun

BA 1: Gerades Anschlussgleis mit Entstörkondensator, 166 mm (für Analogbetrieb, bei Digitalbetrieb Entstörkondensator entfernen), Anschlusskabel mit Kabelsteckhülsen unter der Bettung steckbar.

BA 1: Sidings with anti-interference capacitors, 166 mm (for analogue operation, remove the anti-interference capacitor during digital operation), power cable that can be connected with the cable push-on contact under the roadbeds.

Art.-Nr: 83740 (ohne Abb.)	UVP in €: 4,80	
Art.-Nr: 83741 (ohne Abb.)	UVP in €: 4,80	NEU braun

Mini-Holzschrauben, zur Befestigung von Bettungs-Gleismaterial 1,4 x 15 mm  
(Beutel à 100 Stück)

Mini wooden screws for the attachment of roadbed track material 1.4 x 15 mm (bag of 100)



Art.-Nr: 08976	UVP in €: 9,00	
----------------	----------------	--

Elektrischer Weichenantrieb, zum Nachrüsten der Handweichen, Art. 83816/817, 83861/862  
Electric point mechanism, for the retrofitting of the manual points, product no. 83816/817, 83861/862



Art.-Nr: 83960	UVP in €: 15,50	
----------------	-----------------	--



Motorischer Weichenantrieb für Bettungsgleis-Weichen  
Point-motor for TILLIG-bedding-track points

Art.-Nr.: 08331	UVP in €: 33,95	
-----------------	-----------------	--

Beispiele für mögliche Gleisentwicklungen / Examples of possible track developments

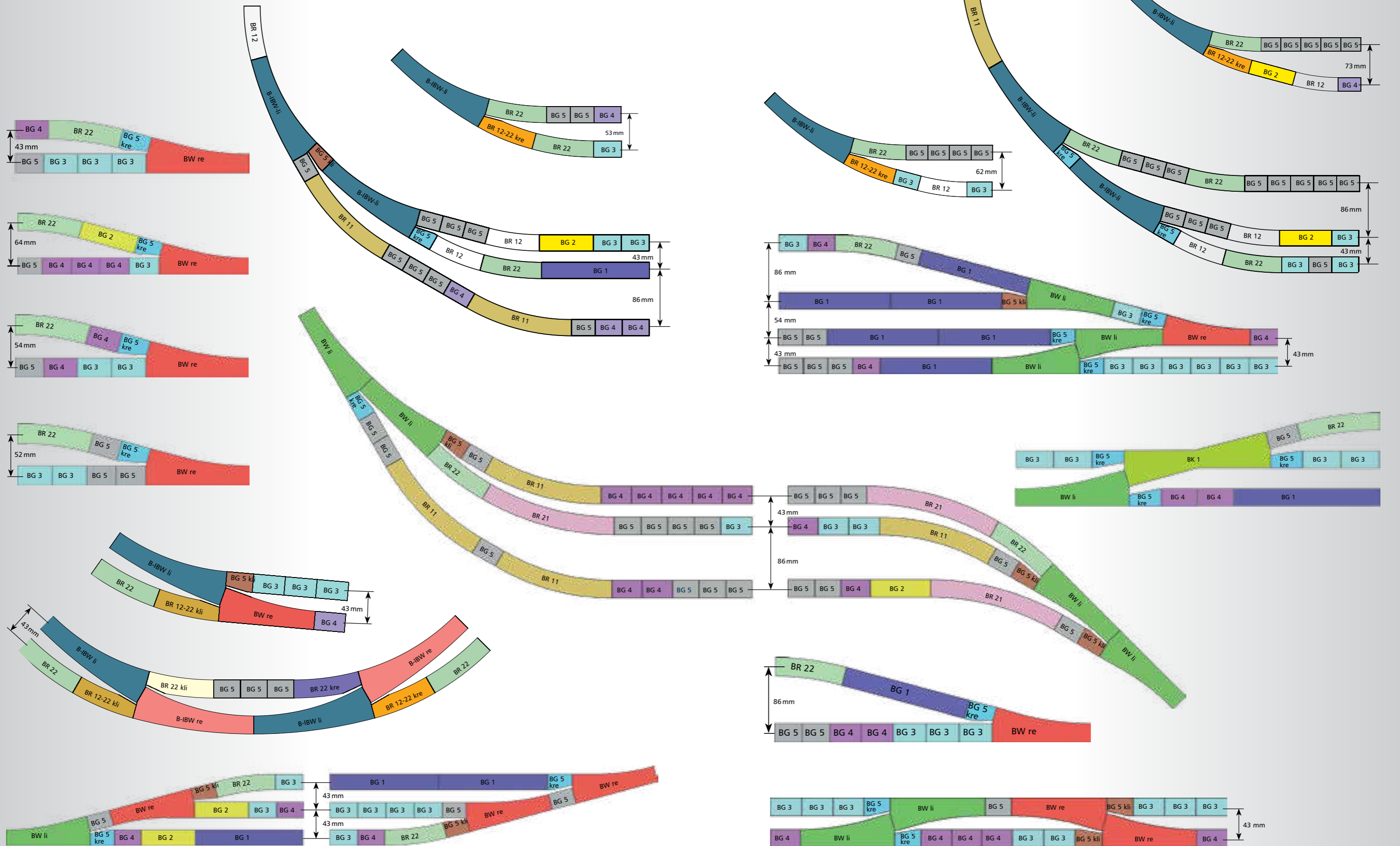

Das TT-Modellgleissystem / The Advanced track system

Unser TT-Modell-Gleissystem mit 2,07 mm hohen Schienenprofilen aus Neusilber entspricht den heutigen hohen Qualitätsansprüchen an ein modernes Modellbahn-Gleis. Es lehnt sich im Äußeren stark an das Vorbild an. Für den anspruchsvollen Gleisbau stehen Ihnen neben blanken auch brünierte Schienenprofile zur Verfügung, die ein vorbildnahes Erscheinungsbild ergeben.

Für den Bau Ihrer Weichenstraßen können Sie zwischen Weichen verschiedener Herzstückwinkel wählen, von platzsparenden 15°-Weichen bis hin zu eleganten schlanken Weichen mit einem Herzstückwinkel von 12° und federnden Weichenzungen. Neben einfachen Weichen erhalten Sie zahlreiche weitere Formen wie Innenbo-

gen-, Außenbogen- und Doppelkreuzungsweichen, doppelte Gleisverbindungen oder ganz neu: Unsere Dreiwegeweiche. Zusätzlich zu den angebotenen Gleisradien lässt sich jeder beliebige Radius mit Flexgleis realisieren. Hier ist für den ernsthaften Modellbahner die Auswahl verschiedener Schwellenarten möglich: Die allgemein übliche Holzschwelle, eine Stahlschwelle, die in der Epoche II weitläufig eingeführt war und bis zum Einsatz der dritten angebotenen Schwellenart, der Betonschwelle, im Gleisbau eingesetzt wurde. Somit ist mit unserem Modell-Gleissystem ein umfassendes Angebot gegeben, um eine dem Vorbild entsprechende Strecke aufzubauen. Dem Individualisten werden fast alle Gleiselemente auch als Bausatz angeboten. Da bei diesen aufwändiges Löten, Kleben und Profilnageln entfällt, geht der Selbstbau schnell und problemlos von der Hand. Diese Art der Gleisverlegung gestattet bei Verwendung von Flexstegweichen-Bausätzen (Art. 83420, 83421) eine sehr individuelle Gleisgeometrie und ist darüber hinaus auch preisbewusst. Ergänzt wird unser Modell-Gleissystem schließlich durch unsere STYROSTONE®-Gleisbettung mit echtem Schottermaterial. Durch diese erhalten die Gleise auf schnelle und einfache Art ein Schotterbett, ohne dass ein aufwendiges Einschottern per Hand notwendig wird.

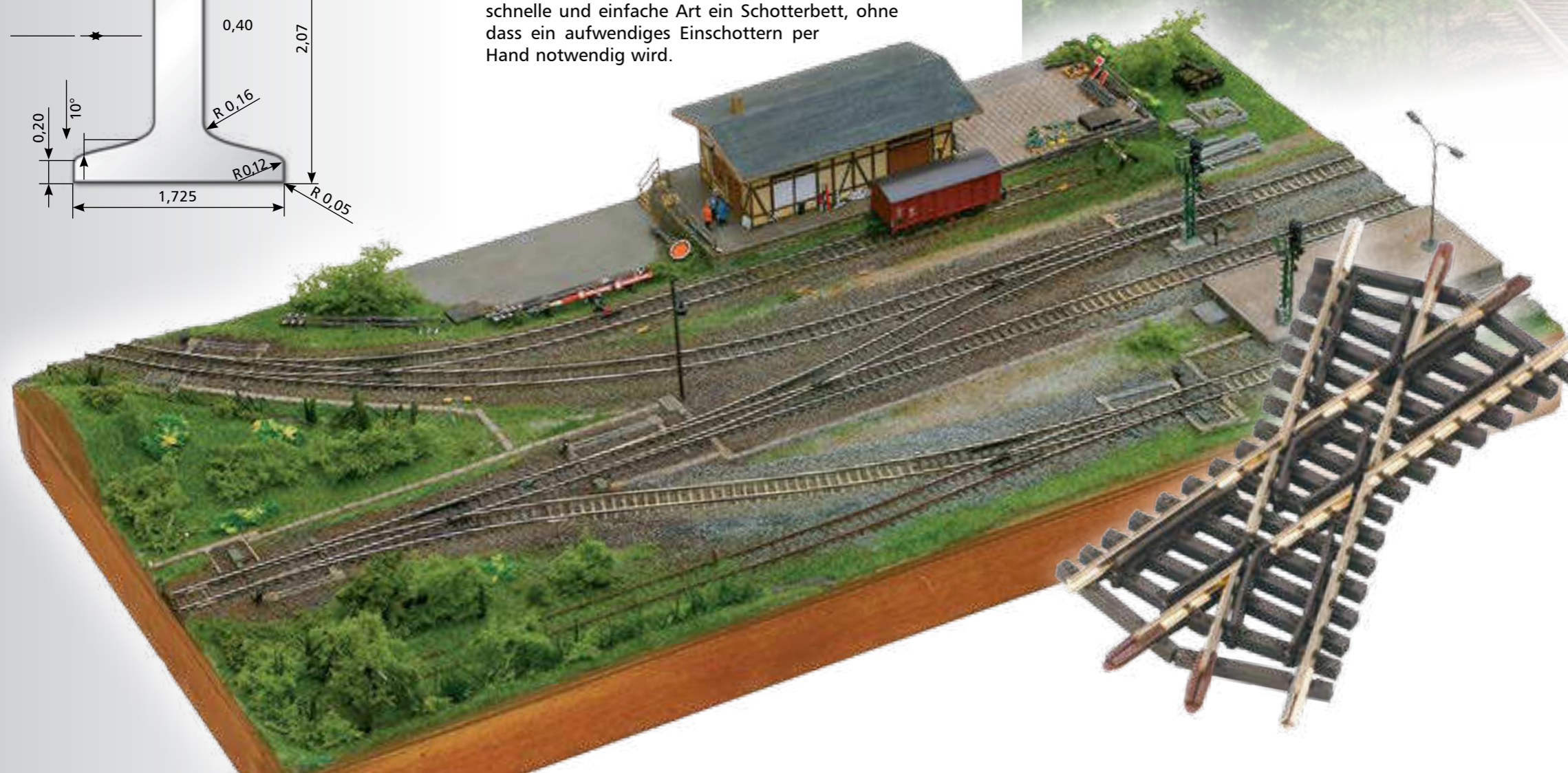
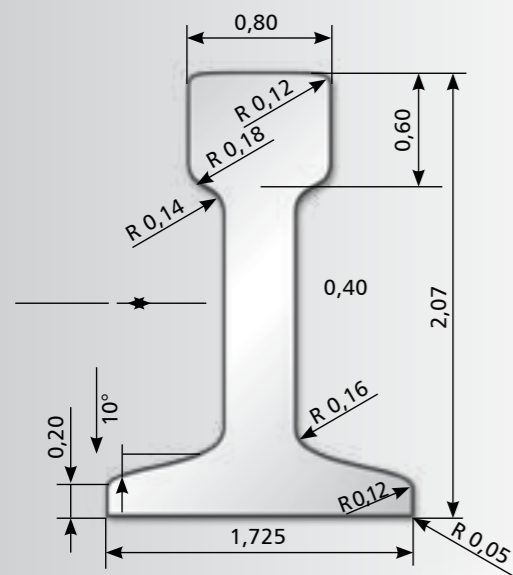

Our TT model track system with 2.07 mm high rail profiles of nickel silver meets a high quality demand of modern model track. It looks like the original. For sophisticated track construction rail profiles both are available in nickel silver and browned to match the appearance of the original.

To design a set of points you have the choice between points with several frog angle, from space-saving 15° points to sharp and slim points with a frog angle of 12° and moveable blade. In addition to straight points you receive a lot of points like curved points, Y-points and slip points as well as doubled track connection (DGV). Additional to the offered track radii you can design any radius with flexible track. So the serious model railwayman can choose between different types of sleepers: the normal wooden- sleeper, the steel-sleeper which established in epoch II and was used in track construction until the third type of sleeper, the concrete-sleeper, was offered.

Therefore you receive with our model track system a comprehensive offer to design a track corresponding the original. The individualist is offered almost all track elements as a kit. Because gluing, soldering and nailing profiles is dropped it is easy and trouble-free to design it yourself. This way of track laying provides the opportunity to design an individual track geometry when using flexi-track and it is also low priced.

Our model track system is rounded off with STYROSTONE®-track bedding with real ballast. That is a fast and easy way to get a ballast bed for tracks, extensive manually ballasting is not necessary.

Gerade Gleise / Straight tracks

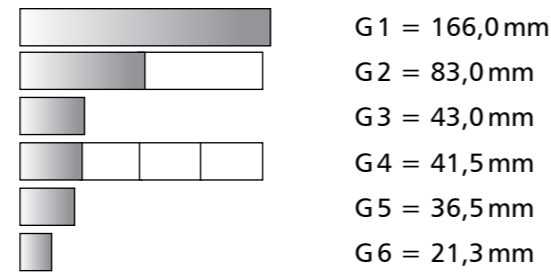

G1: Gerades Gleis, 166 mm  
G1: Straight track, 166 mm

Art.-Nr: 83101 UVP in €: 1,80



G2: Gerades Gleis, 83 mm  
G2: Straight track, 83 mm

Art.-Nr: 83102 UVP in €: 1,80



G3: Gerades Gleis, 43 mm  
G3: Straight track, 43 mm

Art.-Nr: 83105 UVP in €: 1,80



G4: Gerades Gleis, 41,5 mm  
G4: Straight track, 41,5 mm

Art.-Nr: 83103 UVP in €: 1,80

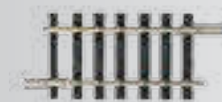

G5: Gerades Gleis, 36,5 mm  
G5: Straight track, 36,5 mm

Art.-Nr: 83104 UVP in €: 1,80



G6: Gerades Gleis, 21,3 mm  
G6: Straight track, 21,3 mm

Art.-Nr: 83120 UVP in €: 1,80



Übergangsgleis: Standardgleis/Modellgleis, 57 mm  
Adapter track: Standard-/Advanced track system, 57 mm

Art.-Nr: 83132 UVP in €: 2,30

Modulausgleichsstück, Länge 83,0 mm – 88,0 mm  
Module linking track, Length 83,0 mm – 88,0 mm

Bausatz vier Prellböcke  
kit with four buffer stops



NEU / NEW



Art.-Nr: 83442 UVP in €: 11,30 gelb / yellow  
Art.-Nr: 83441 UVP in €: 11,30 grau / grey



Prellbock mit Gleisstück  
41,5 mm  
Buffer stop with track  
41,5 mm

Art.-Nr: 83100 UVP in €: 5,80



Prellbock ohne Gleisstück  
Buffer stop without track

Art.-Nr: 07950 UVP in €: 4,20

Modulausgleichsstück:  
Dieses Gleisstück besitzt verschiebbare Schienenprofile, so dass am Plattenrand eingebaut, diese die Lücke zum benachbarten Anlagenteil durch Herausziehen überbrücken können. Andererseits können sie für den sicheren Transport der Anlagenteile hinter die Plattenkante zurückgeschoben werden.  
Hiermit ist ein Ausgleich von ca. 3 mm möglich.

Module linking track:  
The rail profiles of this track element are designed to remain variable in length, so that, when installed at the edge of a layout board, the profiles can slide out to bridge the gap to a neighbouring layout module. Equally important, the profiles can be pushed back from the board edge to permit safe transportation of the individual layout sections.

Gebogene Gleise / Curved tracks



- R11: Gebogenes Gleis, R 310 mm/30°  
R11: Curved track, R 310 mm/30°  
Art.-Nr: 83109  
UVP in €: 2,20
- R12: Gebogenes Gleis, R 310 mm/15°  
R12: Curved track, R 310 mm/15°  
Art.-Nr: 83110  
UVP in €: 2,00
- R14: Gebogenes Gleis, R 310 mm/7,5°  
R14: Curved track, R 310 mm/7,5°  
Art.-Nr: 83113  
UVP in €: 2,00



- R21: Gebogenes Gleis, R 353 mm/30°  
R21: Curved track, R 353 mm/30°  
Art.-Nr: 83106  
UVP in €: 2,20
- R22: Gebogenes Gleis, R 353 mm/15°  
R22: Curved track, R 353 mm/15°  
Art.-Nr: 83107  
UVP in €: 2,00
- R24: Gebogenes Gleis, R 353 mm/7,5°  
R24: Curved track, R 353 mm/7,5°  
Art.-Nr: 83114  
UVP in €: 2,00

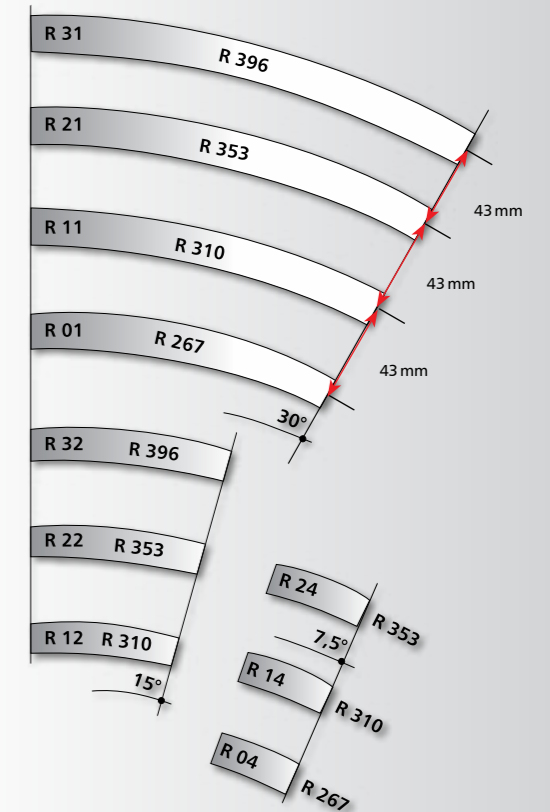

- R31: Gebogenes Gleis, R 396 mm/30°  
R31: Curved track, R 396 mm/30°  
Art.-Nr: 83111  
UVP in €: 2,20
- R32: Gebogenes Gleis, R 396 mm/15°  
R32: Curved track, R 396 mm/15°  
Art.-Nr: 83112  
UVP in €: 2,00



- R01: Gebogenes Gleis, R 267 mm/30°  
R01: Curved track, R 267 mm/30°  
Art.-Nr: 83116  
UVP in €: 2,20
- R04: Gebogenes Gleis, R 267 mm/7,5°  
R04: Curved track, R 267 mm/7,5°  
Art.-Nr: 83115  
UVP in €: 2,00

**Achtung!** Der Radius R 01/R 04 ist nur für Industriegleise und dem Einsatz von kurzen 2-achsigen Fahrzeugen geeignet!

**Attention!** The R 01/R 04 radius is appropriate for industrial tracks and the use of short 2 axle vehicles!

Flexgleise / Flexible Tracks

Holzschwellenflexgleis,  
Länge ca. 664 mm  
Wooden-sleeper flexi-track,  
Length approx. 664 mm

Art.-Nr: 83125 UVP in €: 5,80



Stahlschwellenflexgleis,  
Länge ca. 520 mm  
Steel-sleeper flexi-track,  
Length approx. 520 mm

Art.-Nr: 83136 UVP in €: 5,30



Betonschwellenflexgleis,  
Länge ca. 520 mm  
Concrete-sleeper flexi-track,  
Length approx. 520 mm

Art.-Nr: 83134 UVP in €: 5,30



**Hinweis/Note:**  
Flexgleise werden ohne  
Schienenverbinder geliefert.  
Flexible tracks are delivered  
without rail joiners.

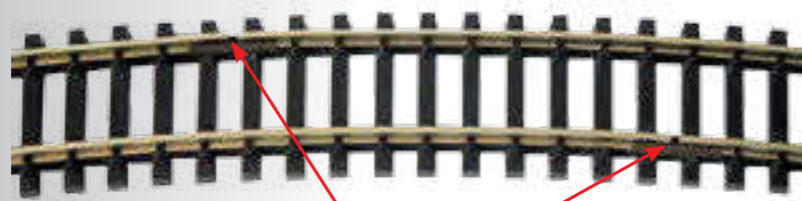

Beim Verlegen von Flexgleis im Gleisbogen sollten die Stoßstellen der Profile versetzt eingebaut werden! Damit werden Knicke im Gleisbogen vermieden.

The profile joints should be staggered when laying flexi-track for track curves! This helps to prevent kinking in the curve.

Flexgleise / Flexible Tracks

- Für individuelle Radien und großzügige Gleisbögen
- Realistischer Gleisoberbau durch drei verschiedene Schwellenarten
- Kombination verschiedener Schwellenarten ist durchaus vorbildtypisch (z. B. Streckengleis – Betonschwelle, Brücken und Weichen – Holzschwelle)

- Used anywhere where individual radii are required or perhaps when a more spacious situation is available
- TILLIG offers three kinds of sleepers
- A combination of different sleeper materials is not unusual, offers close to the original many situations (sleeper track on modern routes and for instance wooden sleepers on girder bridges)

Das Modellgleis-Weichensystem / The advanced track points system

Großzügigkeit und vorbildnahe Aussehen werden die Modellgleis-Weichen mit einem Herzstückwinkel von 12° gerecht. Oft steht dem Modellbahner allerdings weniger Platz zur Verfügung, so dass für den Aufbau der interessanten, aber meist umfangreichen Nebengleisanlagen der Bahnhöfe auch kürzere 15°-Weichen angeboten werden. Die schlankeren Weichen EW 2 und EW 3 sowie unsere ABW, Flexsteg-Bogenweichen und die neuen Baeseler-DKW überzeugen durch ihre vorbildgetreue Nachbildung ohne störende Gelenke (federnde Weichenzungen) und Herzstücken aus gefrästen Profilstücken statt aus Kunststoff bestehend. Neben dem Einsatz der TILLIG-Oberflur-Antriebe (passend für EW 1, Dreiwegeweiche, Innenbogen- und Doppelkreuzungsweichen I) können sämtliche Weichen mit unserem motorischen Unterflurtrieb geschaltet werden, was dem vorbildgetreuen Aussehen Ihrer Gleisanlagen einen weiteren Pluspunkt verschafft.

The model track points with a core angle of 12° are extensive and have an exemplary appearance. However, model railway enthusiasts often do not have that much space at their disposal so shorter 15° points are also offered for the construction of the interesting, but frequently extensive siding sections of the railway stations. The narrower EW 2 and EW 3 points as well as our ABW (outer curve point) Flexsteg curved points and the new Baeseler crossing switch convince through their reproduction that is very faithful to the prototype without disruptive joints (spring loaded switch points) and cores that consist of countersunk moulding members rather than plastic. In addition to the employment of TILLIG surface-mounted drives (appropriate for the standard mark 1 type – EW 1, Three-way points, inner bend points and double crossing points I) all the points can be switched with our motorised underfloor mounted drive which additionally benefits the appearance of your track system in line with the prototype.

Feingefräste Weichenzunge  
Precision-milled switch point

Stabiles Vollprofil mit 2,07 mm Höhe  
Sturdy profile that is 2.07 mm in height

Herzstück aus gefrästen Profilstücken (bei EW 2, EW 3, ABW, Flexsteg-Weichen und DKW Baeseler) / Core made of countersunk moulding members (in the case of EW 2, EW 3, ABW (outer curve point), Flexsteg points and Baeseler double junction points)

Schienenkopfbreite 0,8 mm  
Rail head width 0.8mm

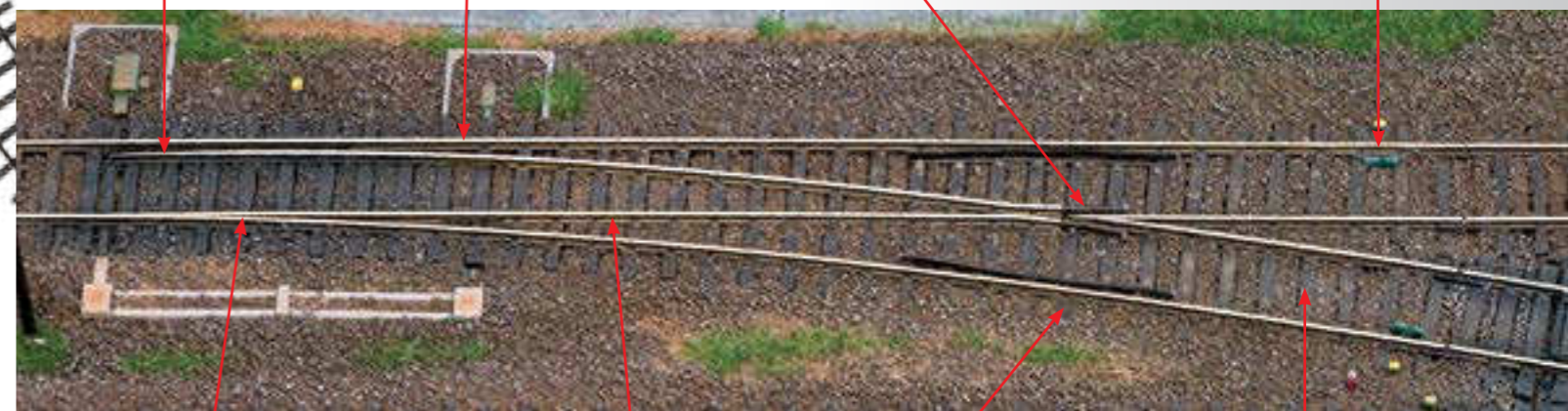

Neben blankem Schienenprofil auch eingefärbtes Profil (brüniert) erhältlich  
It can also be obtained with a coloured profile (burnished) in addition to the bright rail profile

Durchgehende, federnde Weichenzungen (bei EW 2, EW 3, ABW, Flexsteg-Weichen und DKW Baeseler)  
Constant, springy switch points (in the case of EW 2, EW 3, ABW (outer curve), Flexsteg points and Baeseler double junction points)

Vorbildgetreue Kleineisen-Nachbildung  
Faithful reproduction of track fastenings

Holzschwellen mit fein detaillierter Holzmaserung  
Wooden sleeper with very detailed wood grain

**Hinweis / Note:**  
Im Bedarfsfall sind die werksseitig angebrachten Schienenverbinder zu entfernen bzw. umzustecken. / You can remove or change the position of the rail joiners which are mounted by the factory.

Einfache Weichen / Straight points

**Achtung!** Alle Weichen werden ohne Antriebe geliefert.  
**Attention!** All the points are delivered without drives.

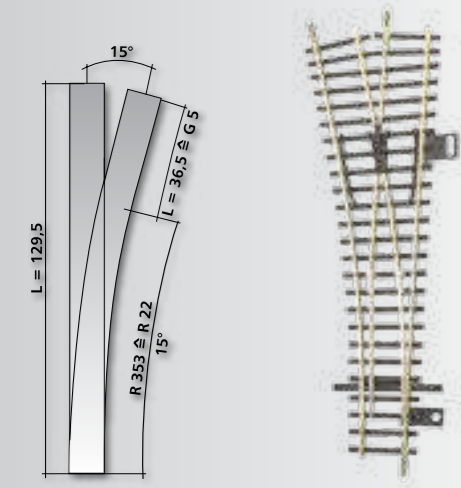

EW 1, links 15°, 129,5 mm  
 EW 1, left points 15°, 129,5 mm



EW 1, rechts 15°, 129,5 mm  
 EW 1, right points 15°, 129,5 mm

Art.-Nr: 83322  
 UVP in €: 13,30

Art.-Nr: 83321  
 UVP in €: 13,30

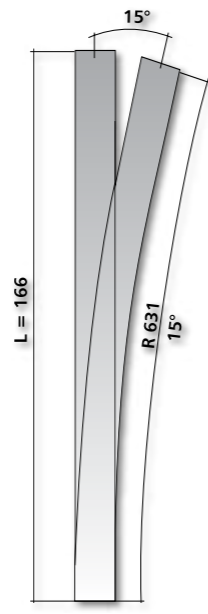

EW 2, links 15°, 166 mm  
 EW 2, left points 15°, 166 mm



EW 2, rechts 15°, 166 mm  
 EW 2, right points 15°, 166 mm

Art.-Nr: 83332  
 UVP in €: 18,30

Art.-Nr: 83331  
 UVP in €: 18,30

Außenbogenweichen /  
 Contrary flexure turnout

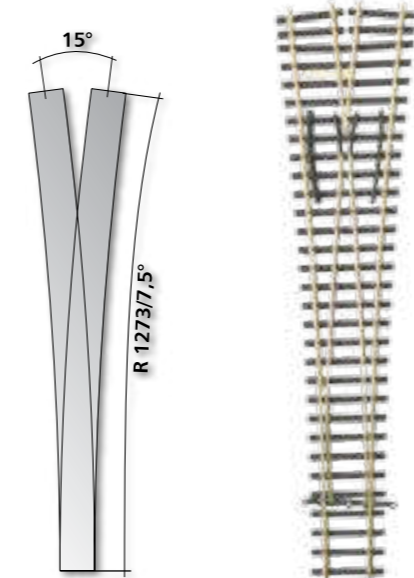

ABW, 15° (2 x 7,5°)  
 symmetrisch/symmetrical

Art.-Nr: 83380  
 UVP in €: 16,10

Dreiwege-Weichen / Three-way points  
 Zur Herzstückpolarisation kann der Schaltrelais-Baustein  
 Art.-Nr. 08414 (S. 226) verwendet werden.

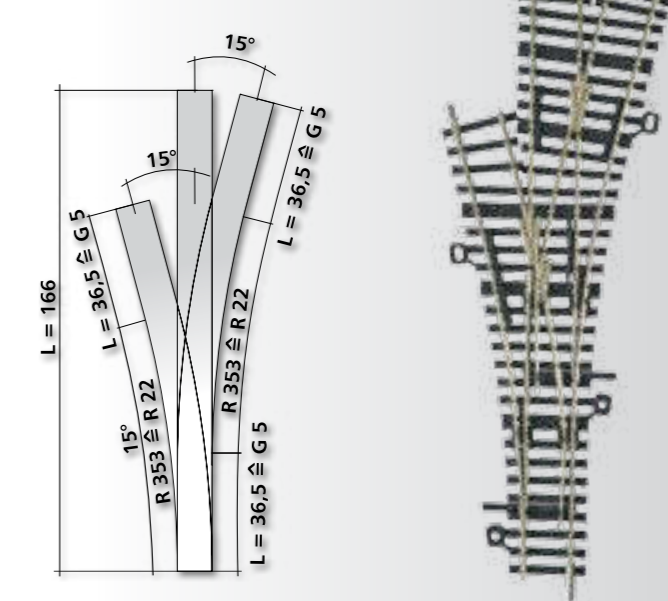

DWW, 2 x 15°, 166 mm  
 asymmetrisch/asymetrical

Art.-Nr: 83230  
 UVP in €: 45,90

Innenbogenweichen / Inside curved points

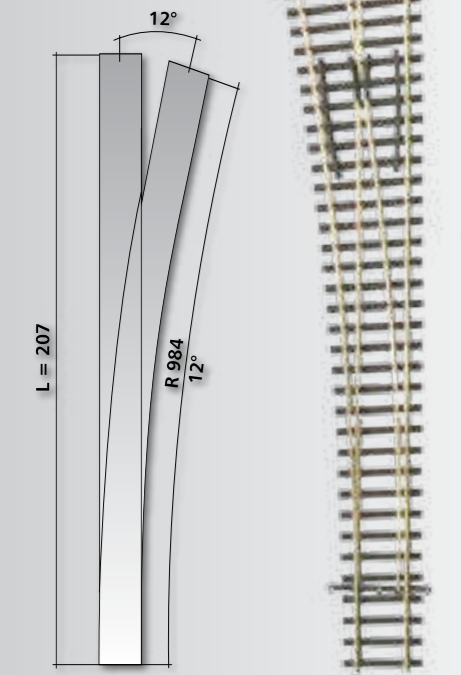

EW 3, links 12°, 207 mm  
 EW 3, left points 12°, 207 mm



EW 3, rechts 12°, 207 mm  
 EW 3, right points 12°, 207 mm

Art.-Nr: 83342  
 UVP in €: 19,50

Art.-Nr: 83341  
 UVP in €: 19,50

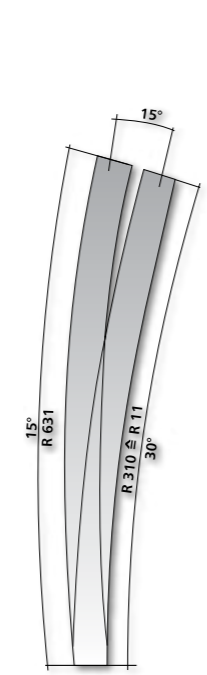

IBW, links  
 IBW, left points



IBW, rechts  
 IBW, right points

Art.-Nr: 83362  
 UVP in €: 13,90

Art.-Nr: 83361  
 UVP in €: 13,90

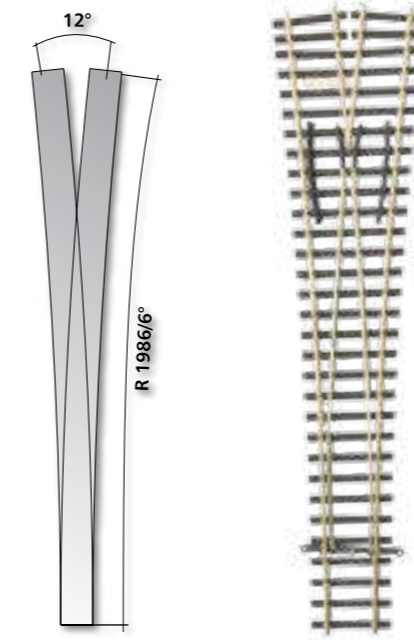

ABW, 12° (2 x 6°)  
 symmetrisch/symmetrical

Art.-Nr: 83382  
 UVP in €: 16,10

Passende Antriebe/Suitable operating gear						
Art.-Nr.	Bezeichnung	83531 – elektr. Weichenantrieb/ Electric operating gear	83532 – elektr. Weichenantrieb/ Electric operating gear	86112 – Unterflur-Motor- Weichenantrieb/ Undermounted points operating motor		
83321	EW 1	x			x	
83322			x		x	
83331	EW 2				x	
83332					x	
83341	EW 3				x	
83342					x	
83380	ABW 1				x	
83382	ABW 2				x	
83361	IBW	x			x	
83362			x		x	
83300	DKW 1	2 x	oder		2 x	
83210	DGV	2 x	und	2 x	oder	4 x
83391	DKW 2				2 x	
83230	Dreiwege- Weiche	x	und	x	oder	2 x



Kreuzungen und Kreuzungsweichen / Crossings and slip points

NEU / NEW

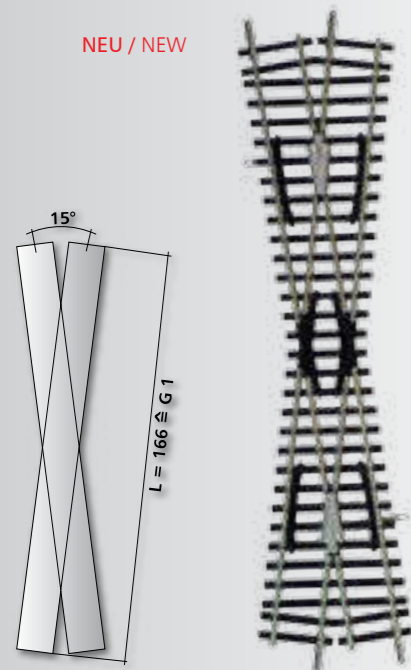

K 1, 15°  
K 1, 15°

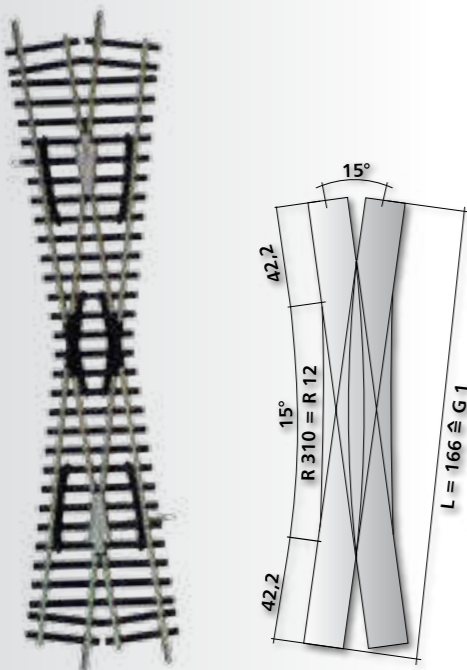

Art.-Nr. 83161  
UVP in €: 15,50

DKW 1  
DKW 1



Art.-Nr. 83300  
UVP in €: 34,90

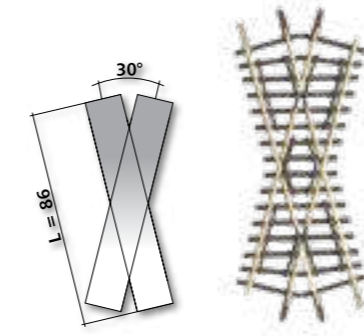

K 2, 30°  
K 2, 30°

Art.-Nr. 83170  
UVP in €: 16,10

**Hinweis/Note:**  
Passende Antriebe,  
Seite 207.  
Suitable operating gear,  
page 207.

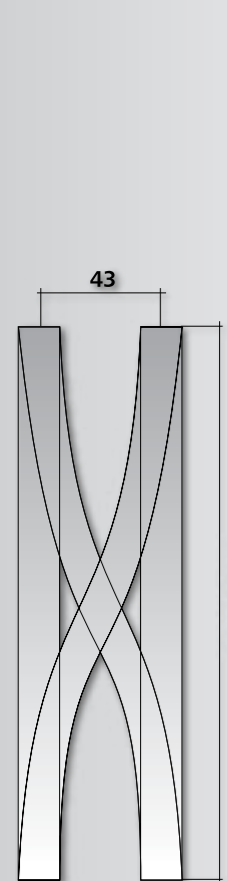

Art.-Nr. 83210  
UVP in €: 91,00

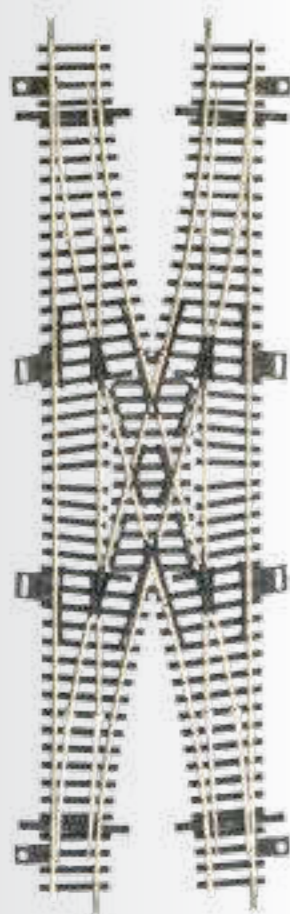

DKW II Bauart „Baeseler“; mit außen-  
liegenden, federnden Weichenzungen  
DKW II type „Baeseler“ with surrounding,  
spring-mounted switch points

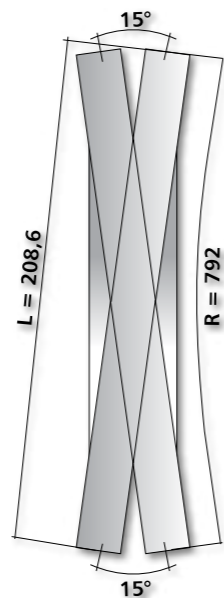

Art.-Nr. 83391  
UVP in €: 52,90

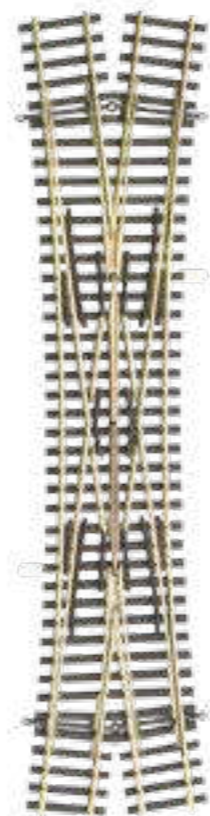

Funktionsgleise / Function tracks



Gerades Anschlussgleis, 166 mm  
(nicht für Digitalbetrieb geeignet)  
Straight railway siding, 166 mm  
(not for digital handling)

Art.-Nr. 83143  
UVP in €: 5,80

Gerades Anschlussgleis, 166 mm  
(für Digitalbetrieb geeignet)  
Straight railway siding, 166 mm  
(for digital handling)

Art.-Nr. 83149  
UVP in €: 5,80

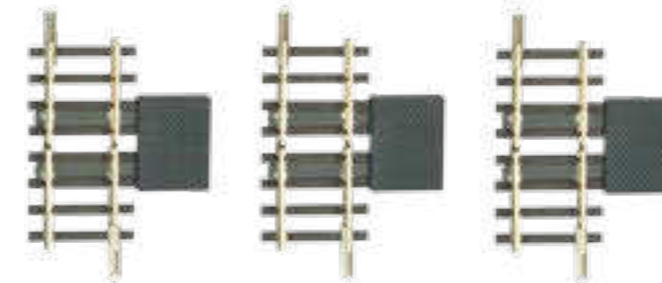

Kehrschleifengarnitur in Verbindung  
mit Analogbetrieb  
Terminal loop set in connection with  
analogue operation

Art.-Nr. 83154  
UVP in €: 15,20

Schaltgleis – 41,5 mm  
(geeignet für Pendelzug-  
steuerung mit TFi2)  
Switching track – 41,5 mm  
(for automated shuttle train  
control by TFi2)



Art.-Nr. 83158 UVP in €: 9,60

Einpoliges Anschlusskabel mit Stecker für Funktions-  
gleise (Länge 890 mm, Querschnitt Kabel 0,15 mm<sup>2</sup>)  
Single-pole connection cable with a plug for functional  
tracks (length 980 mm, cable diameter 0.15 mm<sup>2</sup>)

Art.-Nr. 08912 UVP in €: 2,30

Zweipoliges Anschlusskabel mit Stecker für Funktions-  
gleise (Länge 890 mm, Querschnitt Kabel 0,15 mm<sup>2</sup>)  
2-pole connection cable with a plug for functional  
tracks (length 980 mm, cable diameter 0.15 mm<sup>2</sup>)

Art.-Nr. 08913 UVP in €: 4,70



Entkupplungsgleis,  
elektromagnetisch – 83,0 mm  
Uncoupling track,  
electromagnetic – 83,0 mm

Art.-Nr. 83201  
UVP in €: 18,80



Trenngleis – 41,5 mm  
beidseitig getrennt  
(ohne Anschlüsse)  
Separating track  
(without connections)

Art.-Nr. 83150 UVP in €: 2,30



Unterbrechergleis – 41,5mm  
einseitig getrennt  
(ohne Anschlüsse)  
Separating track (one side)  
(without connections)

Art.-Nr. 83155 UVP in €: 2,30

Trenngleis – 41,5 mm  
beidseitig getrennt,  
mit vier getrennten  
Anschlüssen/Separating  
track with four separate  
connections

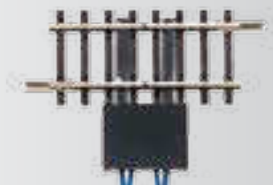

Art.-Nr. 83151 UVP in €: 7,10

Unterbrechergleis –  
41,5 mm einseitig getrennt,  
mit zwei getrennten  
Anschlüssen/Separating  
track (one side) with two  
separate connections

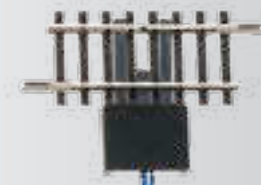

Art.-Nr. 83156 UVP in €: 5,80

Schaltgleis – 41,5 mm  
zum Auslösen von  
Schaltvorgängen durch  
den fahrenden Zug  
Switching track – to trigger  
of switching actions by the  
train driving



Art.-Nr. 83159 UVP in €: 5,80

Selbstbaumaterial, Bausätze/Do-it-yourself materials, kits

**G 1**  
Gerades Schwellenband,  
166 mm  
Straight sleeper strip,  
166 mm

Art.-Nr: 83001 UVP in €: 0,70

**Bogen-Schwellenband**  
R 01 – R 267 mm/30°  
Curved sleeper strip,  
R 01 – R 267 mm/30°

Art.-Nr: 83016 UVP in €: 0,80

**Bogen-Schwellenband**  
R 285 mm/15°  
Curved sleeper strip,  
R 285 mm/15°

Art.-Nr: 83003 UVP in €: 0,70

**Bogen-Schwellenband**  
R 11 – R 310 mm/30°  
Curved sleeper strip,  
R 11 – R 310 mm/30°

Art.-Nr: 83008 UVP in €: 0,80

**Bogen-Schwellenband**  
R 12 – R 310 mm/15°  
Curved sleeper strip,  
R 12 – R 310 mm/15°

Art.-Nr: 83009 UVP in €: 0,70

**Bogen-Schwellenband**  
R 21 – R 353 mm/30°  
Curved sleeper strip,  
R 21 – R 353 mm/30°

Art.-Nr: 83006 UVP in €: 0,80

**Bogen-Schwellenband**  
R 22 – R 353 mm/15°  
Curved sleeper strip,  
R 22 – R 353 mm/15°

Art.-Nr: 83007 UVP in €: 0,70

**Bogen-Schwellenband**  
R 31 – R 396 mm/30°  
Curved sleeper strip,  
R 31 – R 396 mm/30°

Art.-Nr: 83011 UVP in €: 0,80

**Bogen-Schwellenband**  
R 32 – R 396 mm/15°  
Curved sleeper strip,  
R 32 – R 396 mm/15°

Art.-Nr: 83012 UVP in €: 0,70

**Flex-Schwellenband –**  
220 mm, mit dargestellten  
Holzschwellen  
Flexi sleeper strip, 220 mm

Art.-Nr: 83025 UVP in €: 0,70

**Flex-Schwellenband –**  
125 mm, mit dargestellten  
Betonschwellen  
Flexi sleeper strip, 125 mm

Art.-Nr: 83034 UVP in €: 0,80

**Flex-Schwellenband –**  
80 mm, mit dargestellten  
Stahlschwellen  
Flexi sleeper strip, 80 mm

Art.-Nr: 83036 UVP in €: 0,70

**Flexsteg-Bogenweiche –**  
Bausatz, 15°  
passender Antrieb: 86112  
Flexi-curved-points – kit  
frog angle 15°, correspond-  
ing point drive: – 86112

Art.-Nr: 83420 UVP in €: 11,10

**Flexsteg-Bogenweiche –**  
Bausatz, 12°  
passender Antrieb: 86112  
Flexi-curved-points – kit  
frog angle 12°, correspond-  
ing point drive: – 86112

Art.-Nr: 83421 UVP in €: 12,20

**IBW – Bausatz, links**  
passende Antriebe  
– 83532, 83534  
oder 86112  
Inside-curved-points –  
kit left, corresponding  
point drive – 83532,  
83534 or 86112

Art.-Nr: 83410 UVP in €: 10,70

**IBW – Bausatz, rechts**  
passende Antriebe  
– 83531, 83533 oder  
86112  
Inside-curved-points – kit,  
right, corresponding point  
drive – 83531, 83533 or  
86112

Art.-Nr: 83411 UVP in €: 10,70

**EW 1 – Bausatz, links**  
15°, passende Antriebe –  
83532 oder 86112  
left points – kit  
frog angle 15°  
corresponding point drive –  
83532 or 86112

Art.-Nr: 83430 UVP in €: 9,90

**EW 1 – Bausatz, rechts**  
15°, passende Antriebe –  
83531 oder 86112  
right points – kit  
frog angle 15°  
corresponding point drive –  
83531 or 86112

Art.-Nr: 83431 UVP in €: 9,90

**Schienenprofil – blank,**  
Neusilber 2,07 mm,  
1000 mm  
Rail profile – blank,  
nickel silver, 2,07 mm,  
1000 mm

Art.-Nr: 83500 UVP in €: 1,40

**Prellbock (siehe S. 202),**  
Bausatz ohne Gleis  
Buffer stop (p. 202),  
kit, without track

Art.-Nr: 83440 UVP in €: 3,60

**Isolierschienenverbinder,**  
braun (Beutel 20 St.)  
Insulating rail joiners,  
brown (bag of 20)



Art.-Nr: 85502 UVP in €: 3,60

**Isolierschienenverbinder,**  
grau (Beutel 20 St.)  
Insulating rail joiners,  
grey (bag of 20)

Art.-Nr: 86101 UVP in €: 3,65

**Schienenverbinder, blank**  
Neusilber (Beutel à 25 St.)  
Rail joiners, nickel  
silver, blank  
(bag of 25)



Art.-Nr: 86102 UVP in €: 3,60

**Schwellenklammern zur**  
Gleisbefestigung  
(Beutel à 50 St.)  
Sleeper stable  
(bag of 50)



Art.-Nr: 83502 UVP in €: 2,60

**Kontaktklammern brüniert**  
zur Stromzuführung  
(Beutel à 20 Stück)  
Contact clips (bag of 20)



Art.-Nr: 85506 UVP in €: 3,60

Modellgleis, brüniert/Advanced track, browned

Für optisch höhere Ansprüche sind folgende Artikel, in vorbildgerechter Farbgebung, im Angebot/ The following products are on offer in colours that are authentically in line with those of the prototype for higher optical demands:

Fertigartikel

**EW 1 (Fertigweiche/no kit)**  
rechts – 15°, brüniert  
right points – 15°, browned

Art.-Nr: 83326 UVP in €: 14,50

**EW 1 (Fertigweiche/no kit)**  
links – 15° – brüniert  
left points – 15°, browned

Art.-Nr: 83327 UVP in €: 14,50

**Flexgleis, brüniert, 664 mm**  
Flexi-track, browned,  
664 mm

Art.-Nr: 83495 UVP in €: 7,10

Abbildung zeigt eine montierte  
Bausatzweiche EW 2. / The picture  
shows the kit EW 2 mounted.

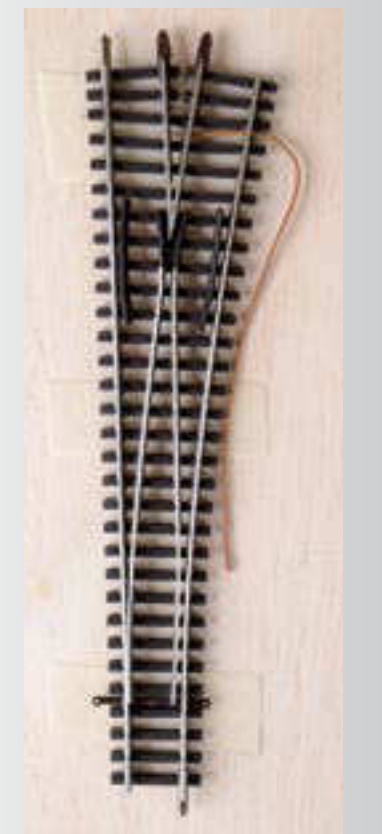

Selbstbaumaterial, Bausätze/Do-it-yourself materials, kits

**EW 1 (Bausatz/kit)**  
links – 15°, brüniert  
left points – 15°, browned

Art.-Nr: 83436 UVP in €: 11,10

**EW 1 (Bausatz/kit)**  
rechts – 15°, brüniert  
right points – 15°, browned

Art.-Nr: 83437 UVP in €: 11,10

**Flexsteg-Bogenweiche**  
(Bausatz/kit), 15°, brüniert  
Flexi-curved-points, frog  
angle 15°, kit, browned

Art.-Nr: 83426 UVP in €: 12,90

**IBW (Bausatz/kit)**  
links, brüniert  
Inside curved points, left,  
browned

Art.-Nr: 83416 UVP in €: 11,10

**IBW (Bausatz/kit)**  
rechts, brüniert  
Inside curved points, right,  
browned

Art.-Nr: 83417 UVP in €: 11,10

**Flexsteg-Bogenweiche**  
(Bausatz/kit), 12°, brüniert  
Flexi-curved-points, frog  
angle 12°, kit, browned

Art.-Nr: 83427 UVP in €: 14,50

**Schienenprofil,**  
2,07 mm,  
Neusilber  
brüniert,  
1.000 mm  
Rail profile, 2.07 mm, nickel  
silver browned, 1.000 mm

Art.-Nr: 85500 UVP in €: 1,50

**Schienenverbinder, Neusilber**  
brüniert (Beutel 25 St.)  
Rail joiners, nickel silver,  
browned  
(bag of 25)

Art.-Nr: 85501 UVP in €: 5,30

Mögliche Einbauvarianten von flexiblen Weichenbau-  
sätzen am Beispiel des Weichenbausatzes 83420 als:  
Installation variants for flexible points kits, for example  
the points kit 83420, as:

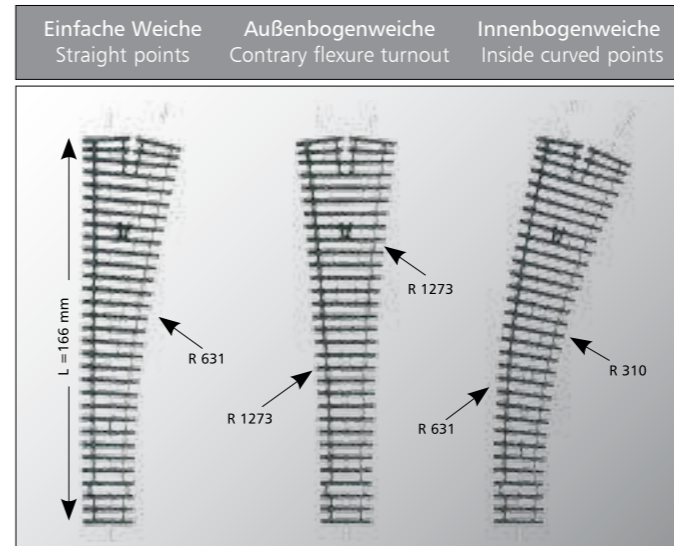

Tipps – Weichenbausätze/Tips – Points kits

Aus den Weichenbausätzen Art.-Nr. 83420, 83421 bzw.  
83426 und 83427 lassen sich Einfach- und Bogenweichen  
bauen, mit denen man Weichenstraßen nach seinen eigen-  
en Wünschen und Platzverhältnissen gestalten kann.  
The points kits with article no. 83420, 83421, 83426 and  
83427 can be used to produce both straight and curved  
points, for points configurations tailored to individual  
wishes and the available space.

Montagetipps/Installation tips

- Den Schwellenrost zuerst nach dem Gleisverlauf auf der Anlagengrundplatte fixieren. / First fix the sleeper strip to the layout base in accordance with the desired track curves.
- Jetzt mit einem Fön den Schwellenrost erwärmen. / Now warm the sleeper strip with a hair dryer.
- Die flexiblen Schwellenstege passen sich nach dem Auskühlen der gewünschten Geometrie an. / After cooling, the flexible sleepers follow the desired geometry.

Tipps und Tricks/Tips and tricks

- Zum Ablängen von Schienenprofil sollten Sie unbedingt einen Gleisschneider oder eine Trennscheibe benutzen.
- Anschließend sollte die Trennkante mit einer feinen Feile entgratet werden.
- Um das Einziehen des Profils in den Schwellenrost zu erleichtern, empfiehlt es sich, den Profilfuß anzuschärfen.

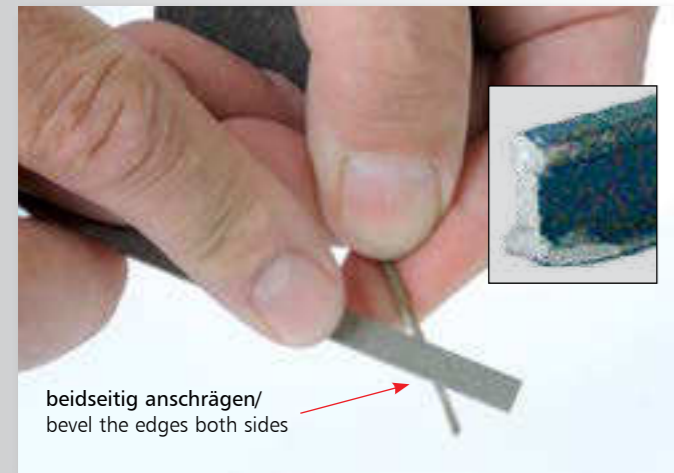

beidseitig anschrägen/  
bevel the edges both sides

- Always use a proper track cutter or abrasive cut-off wheel when cutting rail profiles to length.
- Subsequently, deburr the cut edges carefully using a fine file.
- It is easier to insert the profile into the sleeper strip, if the profile foot is bevelled first.
- Do not use side cutters to insert the profile into the sleeper strip, but use instead flat or pointed pliers!
- When laying track curves, make sure that the individual rail joints are staggered and not opposite each other, otherwise the curve will not run evenly at these track joints and disturbing kinks in the track will be the result (see also note on page 204).
- Again when laying track curves, the profile should be pre-bent to the required track radius before insertion.
- Use flexi-track for radii in excess of R 396 and to compensate length differences.
- As the profiles have been pre-weathered to ensure realistic colouring, the designated solder points for power supply cables must be bared accordingly. This is best done with a glass fibre pen.

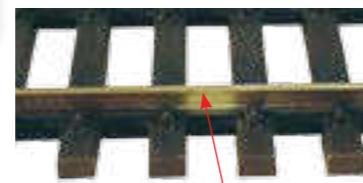

Profil mit einem Glasfaserstift reinigen/  
clean the profile with a glass-fibre pen

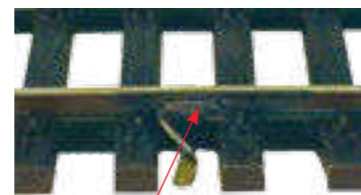

Lötstelle mit entsprechender Farbe behandeln/  
touch up the solder point with the corresponding colour

- Das Profil niemals mit einem Seitenschneider, sondern mit einer Flach- oder Spitzzange in den Schwellenrost einziehen!
- In Gleisbögen unbedingt gegenüberliegende Schienenstöße vermeiden, der Gleisbogen verläuft an diesen Stellen nicht gleichmäßig, es kommt zu unschönen Knicken (siehe auch Hinweis Seite 204).
- Beim Verlegen im Gleisbogen das Profil vor dem Einschleiben entsprechend des Gleisradius vorbiegen.
- Flexgleise bei Radien über R 396 und als Ausgleichstücke verwenden.
- Bei brünierten Gleisen: Durch die vorbildgerechte farbliche Behandlung des Profils muss vor dem Anlöten von Kabeln zur Stromspeisung die entsprechende Stelle am Profil geblenkt werden. Dazu verwendet man einen Glasfaserstift.



TILLIG-Weichenantriebe für Oberflur-Betrieb/Operating gear for surface-mounted operation



Art.-Nr. 83531  
UVP in €: 16,10

Elektrischer Weichenantrieb für Rechtsweichen  
Electric operating gear for right points

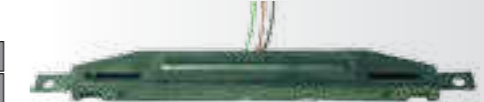

Art.-Nr. 83532  
UVP in €: 16,10

Elektrischer Weichenantrieb für Linksweichen  
Electric operating gear for left points



Art.-Nr. 83533  
UVP in €: 10,70

Hand-Weichenantrieb für Rechtsweichen  
Manual operating gear for right points



Art.-Nr. 83534  
UVP in €: 10,70

Hand-Weichenantrieb für Linksweichen  
Manual operating gear for left points

Hinweis/Note: Art. 85531/85532 sind mit Endabschaltung  
item-no. 85531/85532 with limit switching



Art.-Nr. 08330  
UVP in €: 11,50

Weichenantrieb für alle Weichen  
des Standard-Gleissystems Art. 06110 ff.  
Electric operating gear for points of  
the TT-hollow profile track, item no. 06110 ff.

Unterflur-Motor-Weichenantrieb/Undermounted points operating motor

Unser neuer Unterflurantrieb besteht nun aus einem Grundkörper, der nicht fest in ein Gehäuse eingebaut ist. Daraus resultiert eine wesentliche Vereinfachung bei der Montage unter der Anlage sowie bei der Einstellung des Stellweges. Nach erfolgter Installation des Antriebs wird einfach die beiliegende Staubabdeckung auf den Antrieb gesteckt. Die technischen Parameter des Antriebes bleiben unverändert.

Our new underfloor mounted drive consists of a base body that is not permanently affixed in a housing. This results in a marked simplification during installation beneath the system and also when setting the travel range. The accompanying dust cover will simply be placed on the drive once it has been installed. The technical parameters of the operating motor remain unchanged.

Art.-Nr. 86112  
UVP in €: 19,90

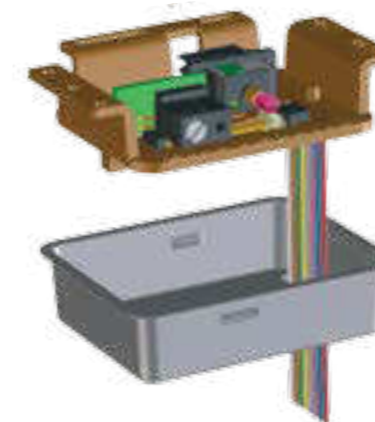

Über den potentialfreien Umschalter kann die Herzstückstromversorgung erfolgen, Gleisabschnitte mit Fahrstrom versorgt werden und Zubehörartikel geschaltet werden. The isolated switcher can be used to supply current to the frog, to provide traction current to track sections and to switch accessories.

Einbauskitze/  
Mounting position:

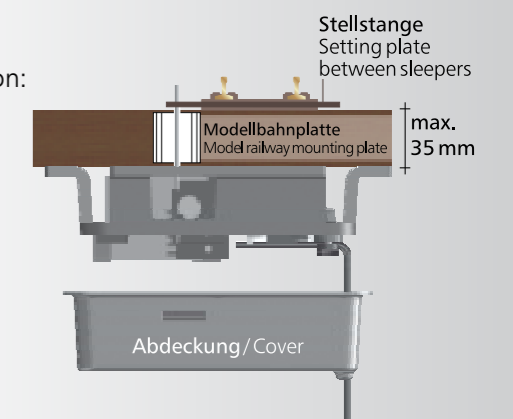

Technische Daten/Technical data:

- Betriebsspannung/Operating voltage: 14 – 16V Wechselspannung
- Stromaufnahme/Current consumption: 75 mA
- Stellweg einstellbar/Switch travel, adjustable: 2 – 10 mm
- Stellkraft/Switching force: 1,47 N = 150 g
- Schaltstrom des potentialfreien Umschalters/  
Switched current of the isolated switcher: 500 mA (max. 24V)
- Abmessungen/Dimensions: 62 x 49 x 23 mm
- Digitalbetrieb/Digital operation: Verwendung des Weichendecoders  
LS 150 (66112)

Gleisschablone/Track strickle



Art-Nr: 83517  
UVP in €: 21,90

Gleisschablone zum Zeichnen von Gleisplänen im Maßstab 1:5, für Feinminienstifte 0,5 mm und Tusche geeignet / Track planning template appropriate for the drawing of the track plan drafts to a scale of 1:5, for fine lead mechanical pencils 0.5 mm and ink

Gleisfiguren/Track figures

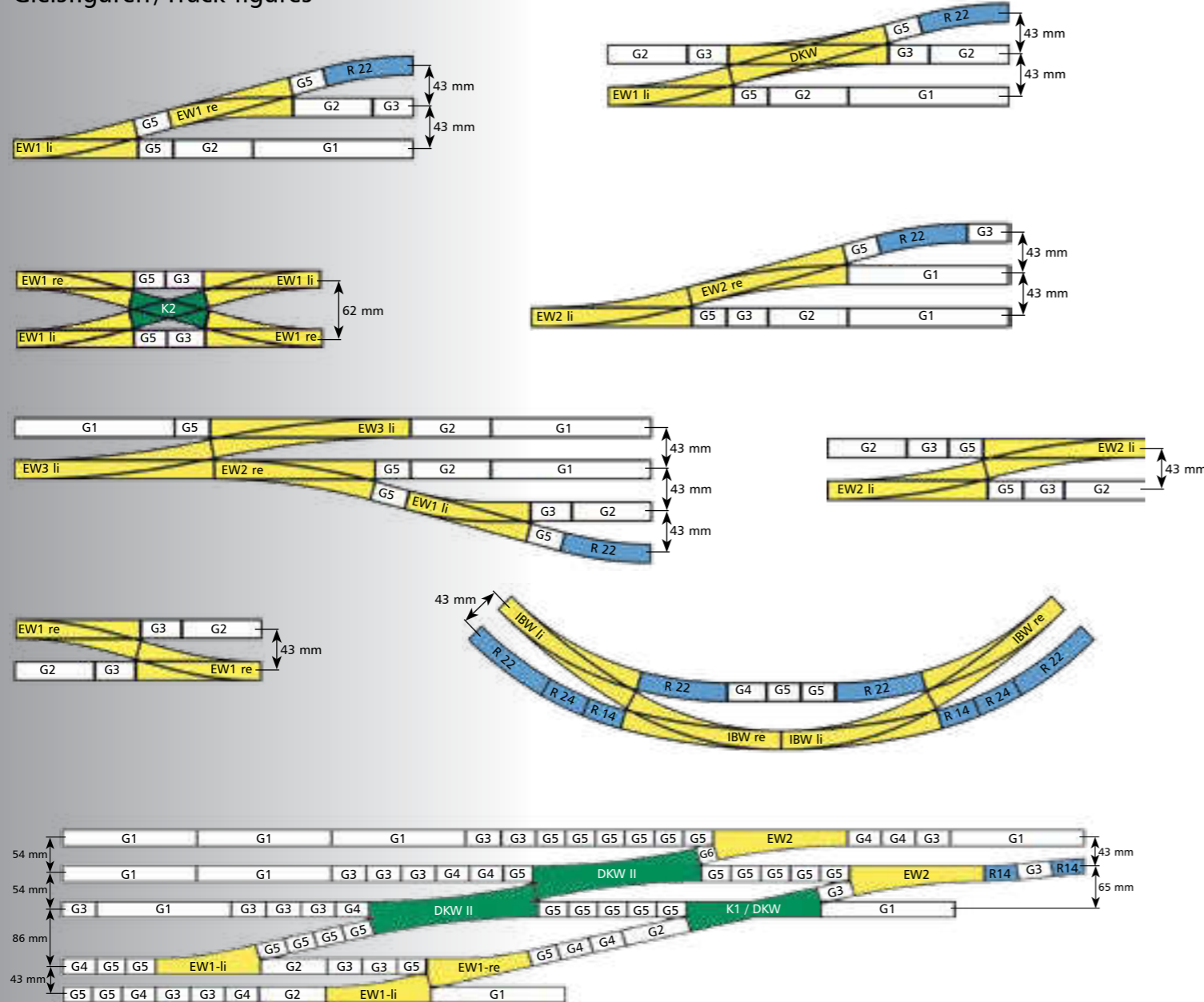

Beispiele für mögliche Gleisentwicklungen / Examples of possible track developments

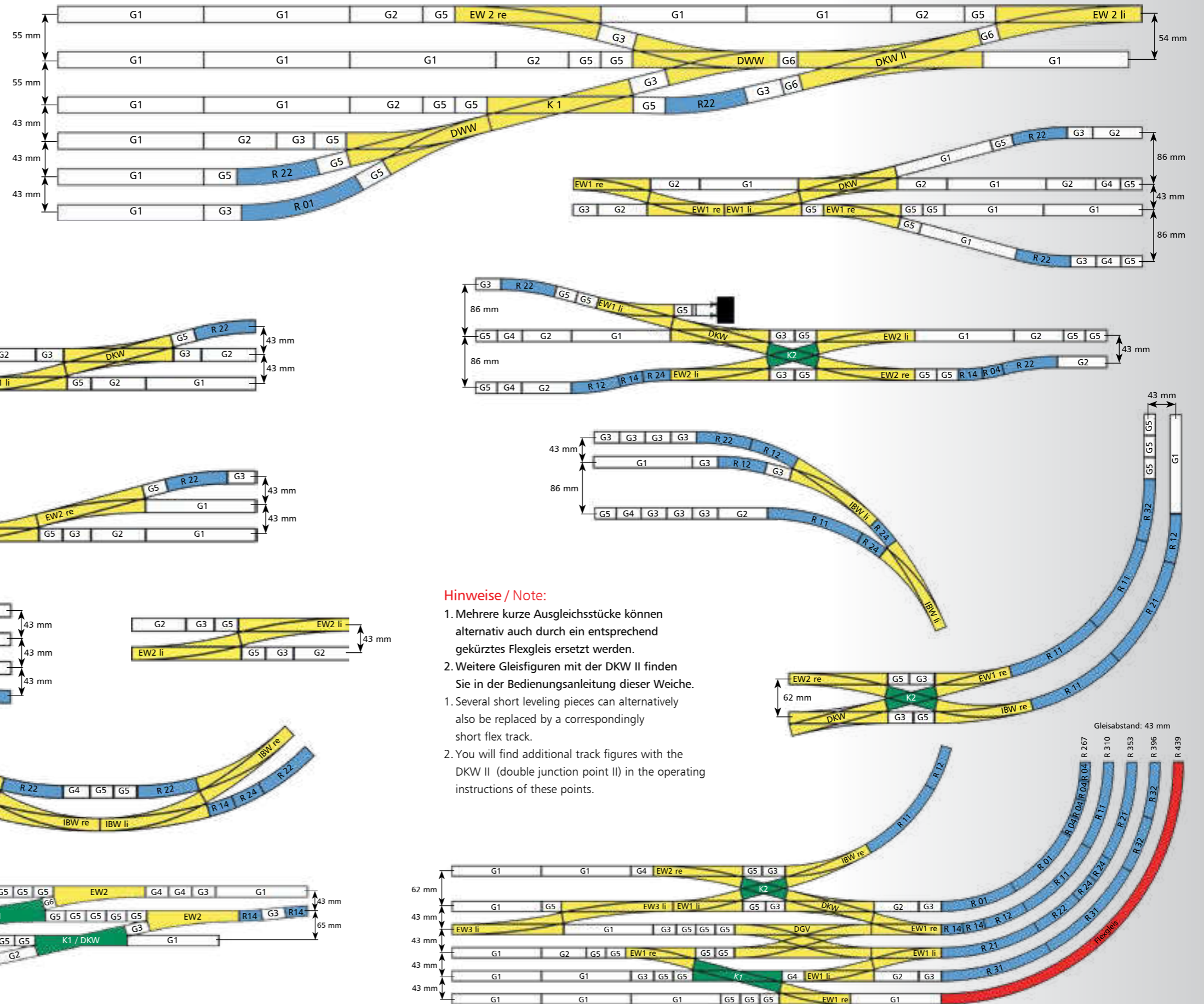

- Hinweise / Note:**
- Mehrere kurze Ausgleichsstücke können alternativ auch durch ein entsprechend gekürztes Flexgleis ersetzt werden.
  - Weitere Gleisfiguren mit der DKW II finden Sie in der Bedienungsanleitung dieser Weiche.
1. Several short leveling pieces can alternatively also be replaced by a correspondingly short flex track.
2. You will find additional track figures with the DKW II (double junction point II) in the operating instructions of these points.

Gleisabstand: 43 mm



# STYROSTONE®-Gleisbettung

## STYROSTONE®-Gleisbettung

Mit der STYROSTONE®-Gleisbettung ist es möglich, schnell und vorbildgetreu die Gleise des TT-Modellgleissystems einzuschottern.

Die Vorteile unseres Systems sind:

- Vorbildentsprechendes Material: Steinschotter
- Schnelle Verarbeitung durch Eindrücken der Gleise
- Keine Nägel, kein Klebstoff oder Leim am Gleis
- Gleise können wieder herausgenommen werden
- Keine Wanderung der Weichmacherbestandteile von Schwellenband und Gleisbettungsgrundkörper dadurch auch äußerst langlebig
- Sehr gute Geräuschdämmung
- Leichte Bearbeitbarkeit der Bettungskörper mit Bastelmesser

Die Bettung wird bei Bogengleisstücken und Geraden ohne Böschung gefertigt, so dass mehrere parallele Gleise aneinander gelegt werden können. Zur Auswahl stehen dunkel oder hell eingefärbte Gleisbettungen zur Verfügung.

Die Böschung ist im Grundkörper vorbereitet und kann mit einem Bastelmesser herausgelöst werden, um eingleisige Strecken darzustellen. Mit dem Steinschotter können Bereiche zwischen den Gleisen und neben dem Schotterbett bestreut werden. Separate Böschungstreifen gestatten die Reparatur verschnittener Teile. Ein zusätzlich unter die Gleisbögen geklebter Streifen ermöglicht die realistische Überhöhung der Gleise in den Bogen. Die Verlegung der Schotterbettung ist sehr einfach. Die Gleise werden in die Bettung gedrückt und STYROPAL-Kontaktklebstoff dünn auf die Unterseite der Gleisbettung aufgetragen. Nach ca. 15 – 20 min. Antrocknungszeit wird die Gleisbettung fest angedrückt. (Der Anpressdruck entscheidet über die Haftfestigkeit!) Arbeitsmittel sind sofort nach Gebrauch mit Wasser zu reinigen.

## STYROSTONE®-track bedding

STYROSTONE®-track bedding permits fast and true-to-life modelling of a ballast bed for the TT Advanced track system.

The advantages of our system are:

- True-to-original material: stone ballast
- Fast laying by pressing in the tracks
- No nails or adhesives required to fix the track
- Tracks can be removed again later
- No migration of plasticisers from the sleeper strip and track bedding core, and consequently excellent durability
- Very good noise-damping effect
- Simple cutting of the bedding core with a craft knife

The bedding is manufactured without embankments for both curved and straight track sections, to enable several tracks to be laid parallel to each other. The track bedding is supplied with a choice of either dark and light colouring.

The necessary cutting marks for an embankment, however, have already been incorporated into the bedding core, meaning that the embankment strips only need to be trimmed off with a craft knife to produce single-track lines. The areas between the tracks and alongside the ballast bed can be strewn with stone ballast. Separate embankment strips permit repairs to bedding sections which may have been prepared incorrectly. Additional strips inserted under the actual bedding provide for a realistic banking of the track in curves. The ballast bed is very simple to lay. The tracks are pressed into the track bedding, and STYROPAL contact adhesive is spread thinly on the underside of the bedding. After a drying time of approx. 15 – 20 min., the track bedding is pressed firmly into place. (It is this application pressure which is decisive for the strength of adhesion!) All tools and aids should be cleaned with water immediately after use.

Gleisbettung für:  
Track bedding for:

Gleisbettung – dunkel (braun)/  
Track bedding – dark (brown)

Gleisbettung – hell (grau)/  
Track bedding – light (grey)



Gerades Gleis/  
Straight track

332 mm:  
G 1, G 2, G 4, G 5

332 mm:  
G 1, G 2, G 4, G 5



Art.-Nr: 86301 UVP in €: 2,20

Art.-Nr: 86351 UVP in €: 2,20

43 mm:  
G 3

43 mm:  
G 3

Art.-Nr: 86306 UVP in €: 2,20

Art.-Nr: 86356 UVP in €: 2,20

Gebogenes Gleis/  
Curved track

R 01 – R 04, 30°

R 01 – R 04, 30°



Art.-Nr: 86302 UVP in €: 2,20

Art.-Nr: 86352 UVP in €: 2,20

R 11 – R 14, 30°

R 11 – R 14, 30°

Art.-Nr: 86303 UVP in €: 2,20

Art.-Nr: 86353 UVP in €: 2,20

R 21 – R 24, 30°

R 21 – R 24, 30°

Art.-Nr: 86304 UVP in €: 2,20

Art.-Nr: 86354 UVP in €: 2,20

R 31 – R 32, 30°

R 31 – R 32, 30°

Art.-Nr: 86305 UVP in €: 2,20

Art.-Nr: 86355 UVP in €: 2,20

Flexgleis/Flexi-track

700 mm  
(Holzschwellen / wooden sleepers)

950 mm  
(Holzschwellen / wooden sleepers)



Art.-Nr: 86308 UVP in €: 5,30

Art.-Nr: 86358 UVP in €: 5,30



700 mm  
(Betonschwellen / concrete sleepers)

700 mm  
(Betonschwellen / concrete sleepers)

Art.-Nr: 86310 UVP in €: 5,30

Art.-Nr: 86360 UVP in €: 5,30

Gleisbettung für:  
Track bedding for:

Gleisbettung – dunkel (braun)/  
Track bedding – dark (brown)

Gleisbettung – hell (grau)/  
Track bedding – light (grey)

Gleisbettung für:  
Track bedding for:

Gleisbettung – dunkel (braun)/  
Track bedding – dark (brown)

Gleisbettung – hell (grau)/  
Track bedding – light (grey)

Einfache Weiche/  
Straight points

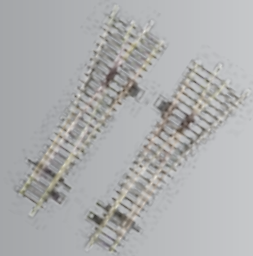

EW 1 (83321) 15°  
rechts/right branch

Art.-Nr: 86311 UVP in €: 4,50

EW 1 (83321) 15°  
rechts/right branch

Art.-Nr: 86361 UVP in €: 4,50

EW 1 (83322) 15°  
links/left branch

Art.-Nr: 86312 UVP in €: 4,50

EW 1 (83322) 15°  
links/left branch

Art.-Nr: 86362 UVP in €: 4,50

EW 2 (83331) 15°  
rechts/right branch

Art.-Nr: 86331 UVP in €: 5,10

EW 2 (83331) 15°  
rechts/right branch

Art.-Nr: 86381 UVP in €: 5,10

EW 2 (83332) 15°  
links/left branch

Art.-Nr: 86332 UVP in €: 5,10

EW 2 (83332) 15°  
links/left branch

Art.-Nr: 86382 UVP in €: 5,10

EW 3 (83341) 12°  
rechts/right branch

Art.-Nr: 86341 UVP in €: 5,30

EW 3 (83341) 12°  
rechts/right branch

Art.-Nr: 86391 UVP in €: 5,30

EW 3 (83342) 12°  
links/left branch

Art.-Nr: 86342 UVP in €: 5,30

EW 3 (83342) 12°  
links/left branch

Art.-Nr: 86392 UVP in €: 5,30

Innenbogenweiche/  
Curved points



Abb. zeigt 83361

IBW (83361) 15°  
rechts/right branch

Art.-Nr: 86315 UVP in €: 4,50

IBW (83361) 15°  
rechts/right branch

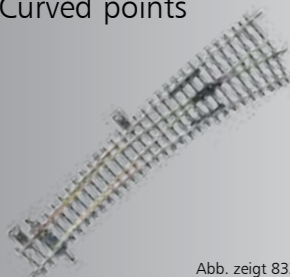
Art.-Nr: 86365 UVP in €: 4,50

IBW (83362) 15°  
links/left branch

Art.-Nr: 86316 UVP in €: 4,50

IBW (83362) 15°  
links/left branch

Art.-Nr: 86366 UVP in €: 4,50

Kreuzung/  
Crossing



Abb. zeigt 83170

K 1 (83161) 15°  
NEU / NEW

Art.-Nr: 86324 UVP in €: 4,50

K 1 (83161) 15°  
NEU / NEW

Art.-Nr: 86374 UVP in €: 4,50

K 1 alt (83160) 15°

Art.-Nr: 86321 UVP in €: 4,50

K 1 alt (83160) 15°

Art.-Nr: 86371 UVP in €: 4,50

K 2 (83170) 30°

Art.-Nr: 86322 UVP in €: 4,50

K 2 (83170) 30°

Art.-Nr: 86372 UVP in €: 4,50

Doppelte  
Kreuzungsweiche/  
Double-slip points



Abb. zeigt 83391

DKW I (83300) 15°

Art.-Nr: 86319 UVP in €: 5,10

DKW I (83300) 15°

Art.-Nr: 86369 UVP in €: 5,10

DKW II (83391) – Baeseler

Art.-Nr: 86320 UVP in €: 7,60

DKW II (83391) – Baeseler

Art.-Nr: 86370 UVP in €: 7,60

Entkupplungsgleis/  
Uncoupling track



83 mm (83201)

Art.-Nr: 86326 UVP in €: 4,50

83 mm (83201)

Art.-Nr: 86376 UVP in €: 4,50

Grundplatte  
(ohne Schotter)/  
Base plate  
(without bedding)

280 x 80 mm

Art.-Nr: 86421 UVP in €: 2,10

280 x 80 mm

Art.-Nr: 86422 UVP in €: 2,10

Böschungstreifen/  
Embankment strip

L = 700 mm

Art.-Nr: 86411 UVP in €: 4,20

L = 700 mm

Art.-Nr: 86412 UVP in €: 4,20



STYROPAL-Kontaktklebstoff  
STYROPAL-contact adhesive

Art.-Nr: 86401  
UVP in €: 4,60

Wasser verdünnbar, nach dem Aushärten wasserbeständig, zum Befestigen von STYROSTONE®-Gleisbettung und zum Fixieren von STYROSTONE®-Schotter.  
Dilutable with water, waterproofed after curing used to fix STYROSTONE®-Track-Bedding and STYROSTONE®-Ballast.



Schotter dunkel, 500 g  
Ballast dark, 500 g

Art.-Nr: 86406  
UVP in €: 11,60



Schotter hell, 500 g  
Ballast light, 500 g

Art.-Nr: 86407  
UVP in €: 11,60

Hinweis / Note: Praktische Tipps zur Verlegung: Seite 204 – 205. / Practical tips on the laying of track bedding: Page 204 – 205.

Praxistipps zur Verlegung

Zur vorbildgerechten Gestaltung einer Modellbahnanlage gehört das Einschottern der Gleise. Dafür eignet sich die TILLIG STYROSTONE®-Gleisbettung besonders gut. Lieferbar ist die Gleisbettung in zwei Farbtönen. Braun eingefärbt, findet sie Verwendung bei älteren Streckenabschnitten und hellgrau für neu gebaute Gleisstraßen. Unsere Gleisbettung wird unter Verwendung hochwertiger Natur- und Kunststoffe in sorgfältiger Handarbeit hergestellt. Der Gleisbettkörper besteht aus extrudiertem Polystyrol-Hartschaum. Das Material ist absolut verrottungsfest, UV-beständig und schwer entflammbar. Der Schotterbelag besteht aus elastischer Gummikorkfolie, auf welcher der form- und maßstabgerechte Steinschotter aufgeklebt ist. Da die Schwellen der Gleise unten etwas breiter sind als oben, sollten Sie den Steinschotterbelag vor dem Eindrücken der Gleise mit dem Fön oder einer Heißluftpistole auf ca. 50° C erwärmen. Das gilt auch beim Herausnehmen der Gleise aus der Bettung. Nach dem Abkühlen des Steinschotterbelages sitzt das Gleis so fest in der Bettung, dass eine zusätzliche Befestigung mit Nägeln nicht erforderlich ist.

Zum Befestigen auf der Anlagengrundplatte empfehlen wir STYROPAL-Kontaktklebstoff (Art.-Nr.: 86401).

Die Gleisbettung ist so vorbereitet, dass bei eingleisigen Strecken auf beiden Seiten, oder bei zweigleisigen Strecken auf einer Seite, die Böschung des Schotters gebildet werden kann. Dazu muss der vorgeschchnittene Styroporkeil entfernt und der Steinbelag seitlich an den Gleisbettkörper angeklebt werden.

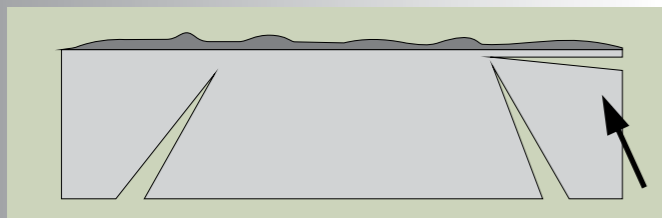
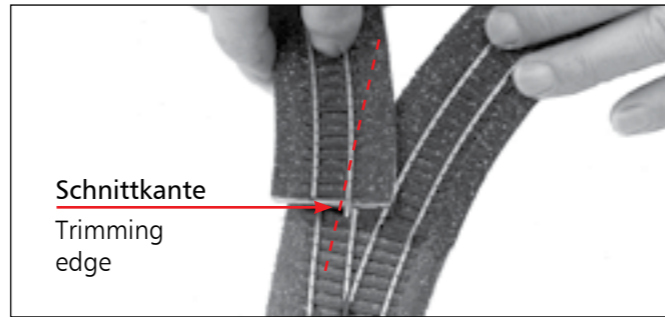

Styroporkeil entfernen/trimm the polystyrene wedge

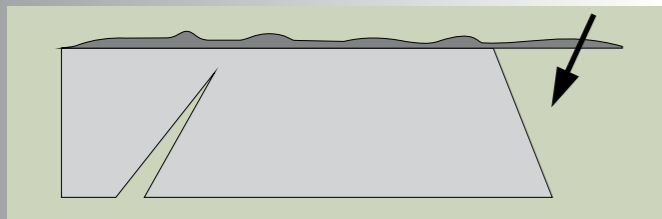

Steinbelag ankleben/glue to the stone surface

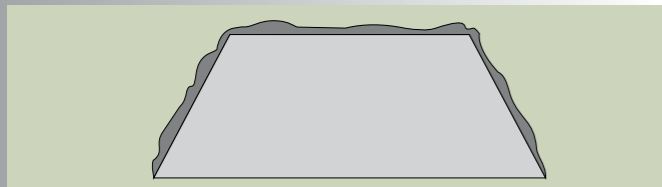

An den Weichenabgängen muss die Gleisbettung angepasst werden. Dazu steckt man ein Teil an die bereits verlegte Weiche und das andere legt man an den Abzweig darüber. Nun können die überlappenden Stücke mit dem Bastelmesser abgeschnitten werden. Die Stoßstellen können anschließend mit dem jeweiligen farblichen Schotter überdeckt werden.

Prinzipiell sollte vor dem Verlegen der Gleisbettung der Verlauf auf der Anlagengrundplatte aufgezeichnet sein. Die Gleiselemente sind vor dem Verkleben der Gleisbettung in diese einzudrücken.

Anlagengrundplatte und Gleisbettung sind gleichmäßig mit STYROPAL-Kontaktklebstoff einzustreichen. Hier kann eine größere Stückzahl vorgearbeitet werden, da der Kleber erst nach dem Trocknen haftet. Sind die Klebeflächen trocken, kann das Gleis angesteckt und die Gleisbettung Stück für Stück angeedrückt werden.

Die Gleisbettung für Flexgleis muss vor dem Andrücken in die gewünschte Richtung gebracht werden. Um ein vorzeitiges Kleben der gesamten Gleisbettung zu verhindern, legt man ein Blatt Papier zwischen die bereits mit Klebstoff versehene Bettung und die Anlagengrundplatte. Dieses entfernt man dann Stück für Stück und drückt die Gleisbettung an.

Practical tips on the laying of track bedding

Reproduction of the original ballast is an important aspect when designing a true-to-life layout. TILLIG STYROSTONE® track bedding is especially convenient in this respect. The track bedding can be supplied in two different colours: brown for use along older track sections, and light-grey for newly built lines. Both variants are the result of careful manual production using only high-quality natural and synthetic materials. The core of the track bedding is composed of extruded hard-foamed polystyrene. This material is absolutely rot-proof, UV-resistant and flame-resistant. The ballast layer comprises an elastic rubber cork foil, to which the true-to-scale stone ballast is adhered. As the sleepers of the tracks are wider at the bottom than at the top, you should use a hair dryer or the like to warm the stone ballast to approx. 50°C before pressing in the track. The same applies when removing the track from the bedding. When the stone ballast layer cools, the track is seated so firmly in the bedding that additional fixing with nails is no longer necessary. For fixing on the layout base, we recommend the use of STYROPAL contact adhesive (item no.: 86401). The track bedding is specially prepared to permit embankments to be recreated – either on both sides for a single-track line, or on one side for lines with two tracks.

To this end, the pre-cut polystyrene wedge is trimmed and the stone surface is glued to the side of the track bed. At points branches, the track bedding needs to be cut to shape. To do so, one strip is laid along the already mounted points, and a second over the top for the branch. The overlap can then be trimmed off using a sharp craft knife. The joint between the two sections can be covered with ballast of the appropriate colour. Before laying track bedding, you should always mark out the course of the tracks on the layout base. The track elements should be pressed into the track bedding before the latter is glued down. Apply an even coating of STYROPAL contact adhesive to the layout base and the track bedding. Several sections can be prepared at once, as the adhesive does not bond until it has dried. Once the coated surfaces have dried, the track can be joined together and pressed down section by section.

The track bedding for flexi-track must be bent to the desired curves before finally being pressed into place. To prevent premature sticking of the whole track bedding, it is recommended to lay sheets of paper between the adhesive-coated bedding and the layout base. This paper can then be removed piece by piece to allow the track bedding to be pressed down and fixed.

Überhöhungstreifen für Gleisbögen, ca. 700 mm lang/  
Banking strips for track curves, length approx. 700 mm

Art.-Nr. 86413  
UVP in €: 1,50

Um das Verlegen im Bogen zu ermöglichen, sind mit der Schere, je nach Radius, in bestimmten Abständen kleinere Keile herauszuschneiden. Anschließend wird der Überhöhungstreifen entsprechend dem vorgezeichneten Streckenverlauf auf der Unterlage festgeklebt und das STYROSTONE®-Gleisbett wird nun auf den Überhöhungstreifen aufgeklebt.

To facilitate laying in the bend smaller wedges must be cut out, depending on the radius, at certain intervals with scissors. Following this the banked strips are stuck to the base in accordance with the sketched out route of the line and STYROSTONE® track bed is now stuck to the banked strips.



**TILLIG-Fahrregler TFi2 mit Impulsbreitenregelung**  
**TILLIG-Controller TFi2 with pulse width control**

- Für alle Gleichstrommodelle 12V =
- Geeignet auch für Glockenankermotoren
- Nahezu konstante Betriebsspannung als gepulste Rechteckspannung
- Ausgangsstrom max. 1 A
- Automatische Abschaltung bei Kurzschluss und Überlast
- Stromversorgung durch energieeffizientes Schaltnetzteil (im Lieferumfang enthalten)
- Aneinanderreihbares Pultgehäuse, Maße ca. 138 x 80 x 40 mm
- For all 12V DC-models
- Compatible with bell-armature motors
- Practically constant operating voltage as a clean, noise-free square wave
- Output current approx. 1 A
- Automatic cut-out in case of short-circuit or overload
- Power supply via mains power adapter (supplied)
- Housing suitable for side-by-side mounting, Dimensions approx. 138 x 80 x 40 mm

**NEW GENERATION**

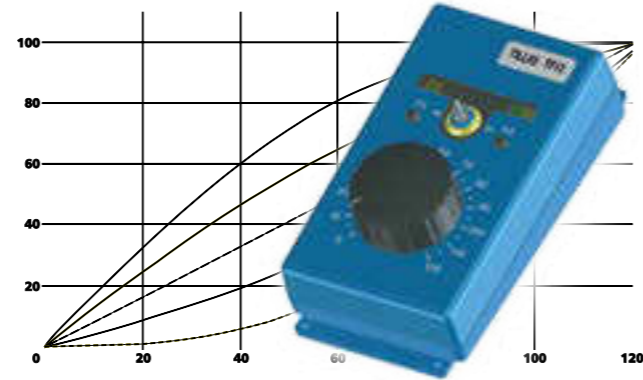

**Mit automatischer Pendelzugsteuerung** Art.-Nr: 08131  
 With automatic shuttle train control UVP in €: 131,90

Eigenschaften und Funktionen wie im digitalen Fahrbetrieb/Same properties and functions as digital systems:

- Hervorragende Fahreigenschaften im gesamten Geschwindigkeitsbereich
- Extreme Langsamfahrten möglich
- Linearer Geschwindigkeitsanstieg im gesamten Regelbereich oder alternativ 4 verschiedene nicht-lineare Regelkurven wählbar
- Abbremsen zum Stillstand und wieder Anfahren mit Brems-/Anfahrverzögerung durch Tastendruck

- Excellent running characteristics over the whole speed range
- Extremely slow running speeds possible
- Linear speed increase over the whole control range, alternatively, 4 different non-linear control curves can be selected
- Automatic deceleration to stand still and restarting with braking/starting delay

**Impulsbreitenregelung in neuer Dimension**

- Nahezu konstante LED-Beleuchtung der Modelle, auch im Langsamlauf
- Fahrtrichtungsgerechte LED-Triebfahrzeugbeleuchtung trotz Impulsspannung

**Pulse width control of a new dimension:**

- Practically constant LED illumination in the models, even when travelling slowly
- Correct motor-coach lighting for the chosen running direction, despite the pulsed voltage

**Komfortable Bedienung**

- Geschwindigkeitsregelung durch Drehknopf mit großem Stellweg (270°)
- Leistungsanzeige als ringförmiges LED-Band korrespondierend zur Reglerstellung
- Umschaltung der Fahrtrichtung durch Kippschalter
- Fahrtrichtungsanzeige durch unterschiedliche Farben in der Leistungsanzeige

**Convenient operation:**

- Wide range of adjustment for speed control at the rotary knob (270°)
- Output display as an LED ring strip corresponding to the controller position
- Toggle switch for running direction changes
- Running direction indicated by colour-coding of the display

**Mit automatischer Pendelzugsteuerung**

- Pendelzugautomatik ohne zusätzliche Relais-schaltung (mit Gleiskontakten mit Diodenbeschaltung – Platine Art. 08401/Schaltgleise 83158/83758)
- Beliebige viele Zwischenhalte im Pendelzugmodus
- Automatische Aktivierung der voreingestellten Brems- bzw. Beschleunigungszeit sowie Haltezeit
- Automatik abschaltbar

**With automated shuttle train control**

- Shuttle train automatic control without an additional relay circuit (with rail contacts with diode circuit – Printed circuit board product no. 08401/Switching tracks 83158/83758)
- Any number of stops in the shuttle train mode
- Automatic activation of the preset braking and acceleration time as well as the stopping time
- The automatic control can be switched off



Platine Art. 08401



**TILLIG Fahrregler/TILLIG-Controller:**

**Analog-Fahrregler mit Zubehörschlus**  
 Analogue drive control with accessory output

Art.-Nr: 08132  
 UVP in €: 79,90



- Für alle Gleichstrommodelle 12V =
- Nahezu konstante Betriebsspannung als gepulste Rechteckspannung
- Fahrstrom 0,5A
- Geschwindigkeits- und Richtungssteuerung durch Drehknopf mit Nullstellung
- Integrierter Zubehörschlus (max. 1,4A)
- Kontroll-Leuchten: Bereitschaftsanzeige Fahrstrom und Zubehö, Kurzschlussanzeige
- Automatische Abschaltung bei Kurzschluss und Überlast
- Stromversorgung durch stromeffizientes Schaltnetzteil (im Lieferumfang enthalten)
- Wahlweise als Handgerät oder Tischgerät nutzbar
- Inkl. praktischer Halterung für Anlagengrundplatte, mit der das Gerät leicht und bequem aufgesteckt und wieder gelöst werden kann

- For all 12V DC-models
- Practically constant operating voltage as a clean, noise-free square wave
- Track current 0,5A
- Speed and direction control at the rotary knob with neutral position
- Integrated accessory output (approx. 1,4A)
- Control lamps for track current, accessoires and cut-out display
- Automatic cut-out in case of short-circuit or overload
- Power supply via mains power adapter (supplied)
- Useable as hand-held unit or tabletop unit
- Attachment for mounting plate included

**Universal-Zubehör-Transformator**  
 Ausgangsspannung 14V~ und 16,5V~, max. Belastung 45VA gesamt  
 Universal accessory transformer output voltages 14V~ and 16,5V~, total output rating 45VA

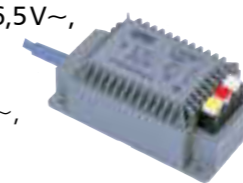

Art.-Nr: 08122 UVP in €: 73,90

**Schaltgleis Nachrüstsatz – Leiterplatte mit 2 Dioden zum direkten Anschluss an TFi2, zum Nachrüsten von Gleisen für alle Spurweiten**

Terminal board with 2 diodes for direct connection to TFi2 controller, for the conversion of tracks for all track widths

Art.-Nr: 08401 UVP in €: 4,80

**Tastenpult für Moment- oder Dauerstrom, aneinander reihbar**  
 Control desk for short impulses or persistent current



Art.-Nr: 08211 UVP in €: 9,50

**Schaltrelais, zweipolig**  
 Switching relays, double-pole



Art.-Nr: 08410 UVP in €: 15,50



**Leistungsaufnahme von TILLIG-Zubehörartikeln/ Power consumption of TILLIG accessory products**

(Bei Betrieb mit 16 V Wechselspannung, Angaben sind Näherungswerte/  
the data contains approximate values in the case of operation with 16V AC voltage)

Schaltrelais Art. 08410/switching relay:	ca. 1000 mA (*)
Schaltrelais Art. 08414/switching relay:	ca. 15 mA (*)
Schaltrelais Art. 08415/switching relay:	ca. 75 mA (*)
Entkupplungsgleis Art. 83201/Uncoupling track:	ca. 1100 mA (*)
Entkupplungsgleis Art. 83801/Uncoupling track:	ca. 150 mA (*)
Oberflur-Weichenantrieb Art. 83531/83532/Electric operating gear:	ca. 1100 mA (*)
Bettungsgleis-Weichenantrieb Art. 83960/Electric operating gear (bedding track):	ca. 1100 mA (*)
Unterflur-Weichenantrieb Art. 86112/Undermounted points operating motor:	ca. 75 mA

(\*) = kurzzeitiger Impulsstrom/temporary impulse current

**Leistungsaufnahme von TILLIG-Rollmaterial/Power consumption of TILLIG rolling stock**

(Bei Betrieb mit 12 V Gleisspannung, Angaben sind Näherungswerte/  
the data contains approximate values in the case of operation with 12V track voltage)

Triebfahrzeug mit Glühlampenbeleuchtung/Tractive unit with light bulb illumination	ca. 200 ... 300 mA
Triebfahrzeug mit LED-Beleuchtung/Tractive unit with LED lighting	ca. 150 ... 250 mA
Steuwagen mit LED-Schlussbeleuchtung/Driving cab coach with LED rear lighting	ca. 5 ... 20 mA
Reisezugwagen mit eingebautem LED-Innenbeleuchtungsbausatz (S. 229)	ca. 5 ... 250 mA
Railway carriage with installed LED-Interior lighting module (refer also to page 229)	
Eilzugwagen mit Glühlampenbeleuchtung/Express train coaches with light bulb illumination	ca. 100 ... 120 mA

**Hinweis/Note:**

Bitte beachten Sie, dass es sich insbesondere bei der Stromaufnahme von Triebfahrzeugen nur um ungefähre Durchschnittswerte handelt. Der genaue Wert kann je nach Alter des Fahrzeuges, der Konstruktion des Modells sowie dem Grad des Verschleißes von Motor und Getriebe des Modells entsprechend abweichen.

Please note that in terms of the power consumption of tractive units these are only approximate average values. The precise value can differ accordingly depending on the age of the vehicle, the construction of the models as well as the degree of wear and tear of the motor and the gearing of the model.

**Unser TILLIG-Kupplungssystem / TILLIG coupling system**



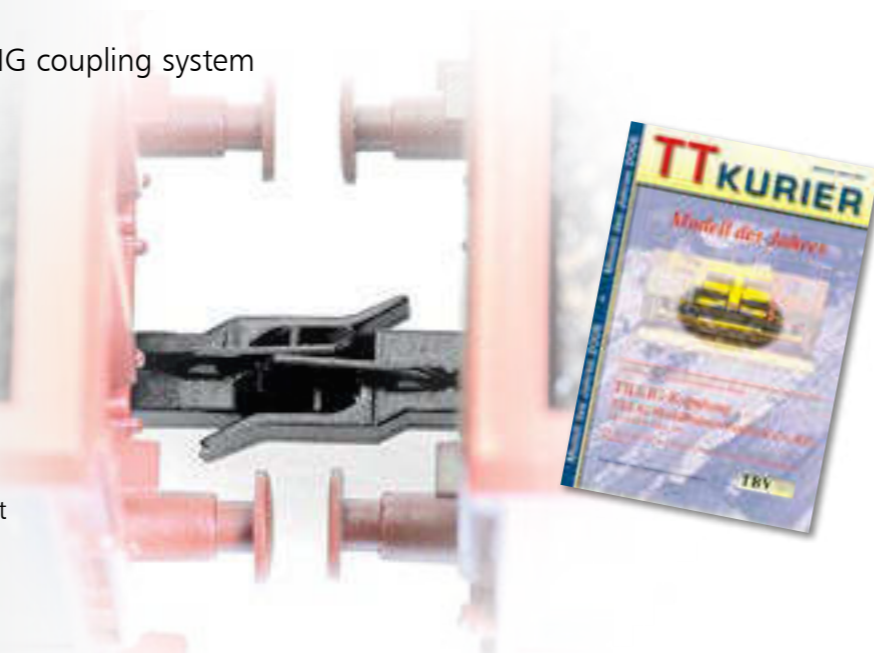



- Zuverlässig im Fahrbetrieb
- Sanftes Ein- und Entkuppeln (mit Entkupplungsgleis/Handentkuppler)
- Ideale Kupplungsform
- Kurzkupplungseffekt bei Fahrzeugen mit Kurzkupplungskinematik
- Reliable driving operation
- Gentle coupling and uncoupling (with uncoupling ramp/Manual uncoupler)
- Ideal coupling form
- Short coupling effect for vehicles with short coupling kinematics







Unser innovatives TILLIG-Kupplungssystem besticht durch völlig neue technische und optische Eigenschaften und löste unser früheres System der Bügelkupplung ab. Die früher eingesetzte Bügelkupplung führen wir weiterhin als START-Kupplung in unserem Sortiment.

Our innovative TILLIG coupling system captivates users through its completely novel technical and optical properties and replaces our earlier bow coupling system. We continue to offer the bow coupling used up to now in our range as a STARTER coupling.

**Überblick Kupplungsausführungen/Overview of coupling type**

 <p>für NEM-Aufnahme Beutel à 8 Stück (Bausatz) for NEM-coupling pocket bag of 8 (kit)</p> <p>Art.-Nr: 08840 UVP in €: 9,10</p> <p>Beutel à 56 Stück (Bausatz) bag of 56 (kit)</p> <p>Art.-Nr: 08841 UVP in €: 48,90</p>	 <p>für Aufnahme der 4-achsigen V 180, Beutel à 2 Stück for coupling pocket of V 180 (4-axle version), bag of 2</p> <p>Art.-Nr: 08842 UVP in €: 3,60</p>	 <p>für Aufnahme der 6-achsigen V 180, NoHAB, T334 mit neuem Rahmen/ neuer Bodenplatte Beutel à 2 Stück for coupling pocket of V 180 (6-axle version), NoHAB, T334 with new frame and new base plate bag of 2</p> <p>Art.-Nr: 08843 UVP in €: 3,60</p>
 <p>für Kuppelkastenaufnahme (E 44, BR 243, BR 119, BR 01 (alte Ausführung), BR 250) Beutel à 2 Stück for trailing box coupling pocket (E 44, BR 243, BR 119, BR 01 (old type), BR 250), bag of 2</p> <p>Art.-Nr: 08846 UVP in €: 3,60</p> <p>Beutel à 20 Stück/bag of 20</p> <p>Art.-Nr: 08849 UVP in €: 21,90</p>	 <p>für Aufnahme der V 200 DR Beutel à 2 Stück for coupling pocket of V 200 DR bag of 2</p> <p>Art.-Nr: 08845 UVP in €: 3,60</p>	 <p>für Schlitzaufnahme (E 94, V 36 (alte Ausführung), V 60, BR 81, BR 92), Zementsilowagen, BTTB-Modelle), Beutel à 10 Stück for slot mount (old design), cement silo waggon, BTTB-models, bag of 10</p> <p>Art.-Nr: 08847 UVP in €: 13,00</p> <p>Beutel à 50 Stück/bag of 50</p> <p>Art.-Nr: 08848 UVP in €: 49,50</p>

**Alte Ausführungen/previous versions**

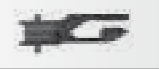
<p>Start-Kupplung, kurz, für Schlitzaufnahme, Beutel à 50 Stück/Starter-Coupling, short, for „Schlitzaufnahme“, bag of 50</p>  <p>Art.-Nr: 08823 UVP in €: 37,50</p>	<p>Steifkupplung für Norm- schacht, Beutel à 20 Stück Formal-Coupling, for NEM coupling pocket, bag of 20</p>  <p>Art.-Nr: 08827 UVP in €: 13,00</p>	<p>Start-Kupplung mit Aufnahme für Norm- schacht, Beutel à 10 Stück Starter coupling for NEM coupling pocket, bag of 10</p>  <p>Art.-Nr: 08872 UVP in €: 13,90</p>	<p>Start-Kupplung mit Auf- nahme für Kuppelkasten Starter coupling for trailing box coupling pocket</p>  <p>Art.-Nr: 210190 UVP in €: 1,20</p>
<p>Start-Kupplung, lang, für Schlitzaufnahme Beutel à 50 Stück Starter-Coupling, long, for „Schlitzaufnahme“, bag of 50</p>  <p>Art.-Nr: 08824 UVP in €: 37,50</p>	<p>Kurzkupplung ohne automat. Funktion mit Aufnahme für Normschacht, Beutel à 20 Stück Short distance coupling for NEM coupling pocket (without automatic mode of operation), bag of 20</p>  <p>Art.-Nr: 08828 UVP in €: 13,00</p>		

### Modellbahnsteuersystem für vorbildgerechten Fahrbetrieb

Model railway control system for realistic operation

Schaltrelais/Zeitschalter – Switching relay/delay timer

Art.-Nr. 08415  
UVP in €: 28,90

Dieses Relaismodul ersetzt die elektro-mechanischen Bausteine Relais und Zeitschalter (Art.-Nr.: 08410 und 08420) durch eine moderne elektronische Lösung. Die Besonderheit liegt darin, dass die Relais- und Zeitschalterfunktion in einem Modul integriert sind und über einen „Jumper“ vom Anwender gesteckt wird. Im Unterschied zu den Vorgängerbausteinen wird hier eine separate Stromversorgung benötigt, die aus jedem Zubehörtrafo (12 – 16 V) entnommen werden kann. Das Modul verfügt über 2 potentialfrei verwendbare Wechselkontakte mit einer maximalen Strombelastbarkeit von je 1 A. Die Steuereingänge „E“ und „A“ sind kurzschlussicher beschaltet, so dass nahezu jedes Steuersignal im Bereich von -16 V bis ca. +0,5 V zum Schalten führt. Sie sind auch zwischen mehreren Relaismodulen untereinander verschaltbar. Auf dem Modul befindet sich ein Stellpotentiometer, über das die Schaltverzögerung eingestellt wird (von ca. 2 Sek. bis ca. 5 Min.). Eine LED signalisiert den Schaltzustand „Relais aus“. Nach dem Bereitstellen der Versorgungsspannung geht das Modul automatisch in diese Vorzugsstellung (LED an).

This relay module replaces the previous electric-mechanical relay and delay timer, article numbers 08410 and 08420, with a modern electronic solution. The special feature of the new solution is the fact that relay and timer functions are integrated into a single module and can be defined by the user by means of a jumper. Unlike its predecessors, the new module requires a separate power supply, which can be taken from any accessory transformer (12 ... 16 V). The module possesses two floating two-way contacts with a maximum current capacity of 1 A each. The control inputs „E“ and „A“ are configured to be short-circuit-proof, ensuring that almost any control signal in the range from -16 V to approx. +0.5 V results in switching. They can also be connected for interdependent switching between several relay modules. A setting potentiometer on the module is used to set the switching delay (range from approx. 2 sec. to approx. 5 min.). An LED signals the switching state „Relay OFF“. When the supply voltage is applied, the module always assumes this preferred state automatically (LED on).

Hinweis / Note: Schaltbeispiele siehe TILLIG-Gleis-Katalog/  
Switching examples you find in our TILLIG track catalogue



Schaltrelais-Baustein  
Switching relays

Art.-Nr. 08414  
UVP in €: 24,90

Das vorliegende Relaismodul ersetzt das elektro-mechanische Relais, Art.-Nr. 08410, durch eine moderne elektronische Lösung in doppelter Ausführung. Das Modul verfügt über je zwei potentialfrei verwendbare Wechselkontakte mit einer maximalen Strombelastbarkeit von je 1 A. Die Steuereingänge „1“ und „2“ sind kurzschlussicher beschaltet, so dass nahezu jedes Steuersignal im Bereich von -16 V bis ca. -8 V zum Schalten führt u. a. Tastenpult gegen Massepotential oder Wechselspannung geschaltet, Gleiskontakte an der Gleismasseseite ange-

bracht, Reedkontakte, Optokoppler usw. Sie sind auch zwischen mehreren Relaismodulen untereinander verschaltbar. Der jeweilig letzte Schaltzustand bleibt auch im stromlosen Zustand erhalten.  
Einsatzmöglichkeiten des Bausteins:  
- Wendezugautomatik  
- Zwischenhalt  
- Automatische Kehrschleifensteuerung  
- Automatische Blocksteuerung  
- Möglichkeit der Herzstückpolarisierung (z. B. Art.-Nr. 83230 Dreiwegeweiche) und der Weichenrückmeldung

The relay module at hand replaces the electric-mechanical relay (Art. No. 08410) with a modern electronic solution in duplicate.  
The model has two potential-free adaptable changeover contacts with a maximum current carrying capacity of 1 A each. The control inputs „1“ and „2“ are wired to be short-circuit protected so that virtually any control signal in the range of -16 V to approx. -8 V leads to switching; among other things, key control console switched against common potential or alternating voltage, track contacts attached to the rail mass side, reed contacts, optical coupler, etc. They can also be interconnected between several relay modules. The respective last switching status is also preserved in a zero-current state.  
Fields of application for the module:  
- Automated push-pull train system  
- Terminal station break  
- Automatic terminal loop control, automatic block control  
- Possibility of core (frog) polarisation (e. g. Art. No. 83230 Three-way Turnout) and turnout feedback



### Werkzeug & Bastelmaterial / Tools & handicraft material

Mini-Holzschrauben zur Befestigung von Gleismaterial schwarz brüniert, 1,4 x 8 mm (100 St.)  
Mini wood screws to fasten the tracks burnished black, 1,4 diameter x 8 mm long (100 pcs./bag)



Art.-Nr. 08970 UVP in €: 8,00

Mini-Holzschrauben zur Befestigung von Gleismaterial schwarz brüniert, 1,4 x 15 mm (100 St.)  
Mini wood screws to fasten the tracks burnished black, 1,4 diameter x 15 mm long (100 pcs./bag)



Art.-Nr. 08976 UVP in €: 9,00

Getriebefett (5g)  
Transmission grease (5g/tin)



Art.-Nr. 08973 UVP in €: 4,70

Reinigungsdestillat, Flasche, 125 ml/Cleaning fluid, bottle, 125 ml

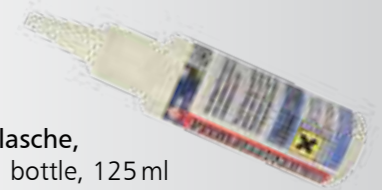

Art.-Nr. 08977 UVP in €: 8,00

Schaltlitze in rot, blau, schwarz und gelb (je 10 m)  
Stranded hook-up wire in red, blue, black, yellow connection cable (each 10-m-length)



Art.-Nr. 08972 UVP in €: 9,10

Gleis-Reinigungsstein „Universal Schleiffix“ (8 x 5 x 2 cm)  
Track cleaning stone „Schleiffix“ universal grinder (8 x 5 x 2 cm)



Art.-Nr. 08974 UVP in €: 8,50

### Zubehör / Accessories

Handentkuppler  
Manuel uncoupler



Art.-Nr. 07920 UVP in €: 4,20

Verteiler (Leiste zum Klemmen)  
Distributor block (Strip for terminal)



Art.-Nr. 08931 UVP in €: 2,50

Kabelhalter (Leiste zum Klemmen)  
Wire holder (Strip for terminal)



Art.-Nr. 08940 UVP in €: 0,90

Aufgleiser Modellgleis  
Rerailer advanced track

Art.-Nr. 07910 UVP in €: 1,50



Aufgleiser Bettungsgleis  
Rerailer bedding track

Art.-Nr. 07911 UVP in €: 1,50

(ohne Abb.)

Kontaktgarnitur, zum Auslösen von Schaltvorgängen durch den fahrenden Zug (nur für Standardgleis BTTB) / Contact set to trigger of switching actions by the train driving (only for BTTB standard track system)



Art.-Nr. 08430 UVP in €: 3,20

Lehre für Radsatz und Gleis für Spur TT 12 mm  
Template for wheel set and track for gauge TT 12 mm



Art.-Nr. 08960 UVP in €: 10,90

Lehre für Radsatz und Gleis für 9 mm  
Template for wheel set and track for 9 mm



Art.-Nr. 08961 UVP in €: 10,90

Spannungsprüfer, zur Feststellung der Polarität am Gleis (geeignet für Nenngröße TT, H0/H0e/H0m und N)  
Charge indicator for the setting of the polarity at the track (ideal for gauge TT, H0/H0e/H0m und N)



Art.-Nr. 08419 UVP in €: 5,80

Zubehör / Accessories

Haftreifen  
Traction tyre



Haftreifen 14 mm,  
Einsatz für BR 23/35, BTTB  
(Beutel à 8 Stück)  
Traction tyre 14 mm  
for BR 23/35, BTTB  
(bag of 8)

Art.-Nr: 08883 UVP in €: 5,80

Haftreifen 8 mm,  
Einsatz für BR 01/119/  
120/221/130, BTTB  
(Beutel à 8 Stück)  
Traction tyre 8 mm  
for BR 01/119/120/221/  
130, BTTB (bag of 8)

Art.-Nr: 08884 UVP in €: 5,80

Haftreifen 10,5 mm,  
Einsatz für BR  
56/250/243, E 44/94,  
BTTB (Beutel à 8 Stück)  
Traction tyre 10,5 mm  
for BR 56/250/243, E44/94,  
BTTB (bag of 8)

Art.-Nr: 08881 UVP in €: 5,80

Haftreifen 9,2 mm,  
Einsatz für BR 110, BTTB  
(Beutel à 8 Stück)  
Traction tyre 9,2 mm  
for BR 110, BTTB  
(bag of 8)

Art.-Nr: 08882 UVP in €: 5,80

Kohlebürsten  
Carbon brush



Kohlebürsten, eckig, Ein-  
satz für runden Motor von  
BTTB (Beutel à 10 Stück)  
Carbon brush for round  
motor of BTTB  
(bag of 10)

Art.-Nr: 08875 UVP in €: 8,00

Kohlebürsten, rund, Ein-  
satz für eckigen Motor  
von TILLIG  
(Beutel à 10 Stück)  
Carbon brush, for square  
Motor of TILLIG (bag of 10)

Art.-Nr: 08876 UVP in €: 6,50

Kohlebürsten für  
Mashima MH 1224,  
Einsatz für V 100  
(Beutel à 10 Stück)  
Carbon brush for Mashima  
MH 1224 (diesel locomotive  
V 100), (bag of 10)

Art.-Nr: 08870 UVP in €: 6,50

Kohlebürsten für  
Mashima M 24-F 11,  
Einsatz für BR 52  
(Beutel à 10 Stück)  
Carbon brush for Mashima  
M 24-F 11 (steam locomotive  
class 52), (bag of 10)

Art.-Nr: 08871 UVP in €: 6,50

Kohlebürsten „Bühler“  
(Beutel à 10 Stück)  
Carbon brush „Bühler“  
(bag of 10)

Art.-Nr: 08877 UVP in €: 6,50

Zwerglampen  
Miniature lamps



Zwerglampen 16V, kurzer  
Kolben, Einsatz für BR 56/  
86 BTTB (Beutel à 6 Stück)  
Miniature lamps 16V, short  
socket for BR 56/86 BTTB  
(bag of 6)

Art.-Nr: 08874 UVP in €: 6,50

Zwerglampen 6V, Einsatz  
für Eilzugwagen im  
Analogbetrieb  
(Beutel à 6 Stück)  
Miniature lamps 6V, for fast  
passenger trains in analogue  
operating (bag of 6)

Art.-Nr: 08878 UVP in €: 6,50

Zwerglampen 10V,  
Einsatz für BR 130/211,  
BTTB; BR 01, E 94,  
Einsatz für Eilzugwagen  
im Digitalbetrieb  
(Beutel à 6 Stück)  
Miniature lamps 10V,  
for BR 130/211, BTTB; BR  
01, E 94, for fast passenger  
trains in digital operating,  
(bag of 6)

Art.-Nr: 08879 UVP in €: 6,50

Zwerglampen 16V,  
langer Kolben, Einsatz  
für BR 110, BTTB, E 94,  
Eilzugpackwagen  
(Beutel à 6 Stück)  
Miniature lamps 16V, long  
socket, for BR 110, BTTB,  
E 94, fast passenger train  
(bag of 6)

Art.-Nr: 08880 UVP in €: 6,50

Radsätze  
Metal wheel set



Metallradsatz Ø 8,0 mm,  
einseitig isoliert (Länge  
18,6 mm/Beutel à 8 Stück)  
Metal wheel set Ø 8,0 mm,  
one wheel isolated  
(length 18,6 mm/bag of 8)

Art.-Nr: 08819 UVP in €: 13,50



Metallradsatz Ø 8,0 mm  
einseitig isoliert (Länge  
18,6 mm/Beutel à 50 Stück)  
Metal wheel set Ø 8,0 mm,  
one wheel isolated  
(length 18,6 mm/bag of 50)

Art.-Nr: 08820 UVP in €: 79,90



Metallradsatz Ø 7,5 mm  
einseitig isoliert (Länge  
18,6 mm/Beutel à 8 Stück)  
Metal wheel set Ø 7,5 mm,  
one wheel isolated  
(length 18,6 mm/bag of 8)

Art.-Nr: 08818 UVP in €: 13,90



Speichenradsatz, beid-  
seitig isoliert (Länge  
18,6 mm/Beutel à 10 Stück)  
Spoked wheel set,  
both wheels isolated  
(length 18,6 mm/bag of 10)

Art.-Nr: 08890 UVP in €: 25,50

Brücken und Pfeiler / Bridges and piers



Bogenbrücke mit Modell-  
gleis, blau, Länge 228 mm,  
Bausatz inkl. einem  
Brückenpfeiler 65 mm  
Bowstring bridge with  
track, blue, length 228 mm,  
kit with one bridge pier  
65 mm

Art.-Nr: 83560 A UVP in €: 12,20



Blechträgerbrücke mit  
Modellgleis, grau, Länge  
228 mm, Bausatz inkl.  
einem Brückenpfeiler  
65 mm  
Girder bridge with track,  
grey, length 228 mm,  
kit with one bridge pier  
65 mm

Art.-Nr: 83571 UVP in €: 12,20

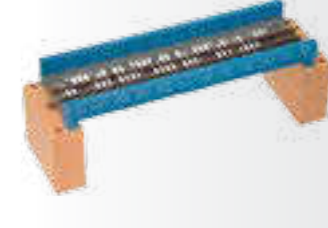

Blechträgerbrücke mit  
Modellgleis, blau Länge  
228 mm – Bausatz inkl.  
einem Brückenpfeiler  
65 mm  
Girder bridge with track,  
blue, length 228 mm,  
kit with one bridge pier  
65 mm

Art.-Nr: 83561 UVP in €: 12,20

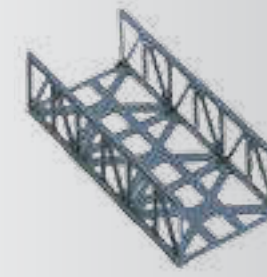

Gitterbrücke ohne Gleis,  
Länge 115 mm  
Lattice bridge without  
track, length 115 mm

Art.-Nr: 07130 UVP in €: 3,60

Brückenpfeiler sandstein-  
farben, Höhe 65 mm  
Bridge pier sandstone,  
65 mm high

Art.-Nr: 07161 UVP in €: 1,90

Brückenpfeiler grau  
Höhe 65 mm  
Bridge pier grey,  
65 mm high

Art.-Nr: 07160 UVP in €: 1,90

Brückenpfeiler grau  
Höhe 23,8 mm  
Bridge pier grey,  
23,8 mm high

Art.-Nr: 07170 UVP in €: 1,60



Innenbeleuchtungsbausätze / Interior lighting kits

Innenbeleuchtungs-Bausatz Universal  
(In Kooperation mit Viessmann) /  
Interior universal lighting kit  
(in cooperation with Viessmann)

Art.-Nr: 08858  
UVP in €: 24,90

- Beleuchtungsstreifen mit variabler Länge (max. 210 mm, kürzbar) / Lighting strip with variable length (max. 210 mm, can be shortened)
- Zur Nachrüstung aller Reisezugwagen, die für den Einbau einer Innenbeleuchtung vorbereitet sind / For the retrofitting of all the railways carriages that are prepared for the installation of interior lighting
- Warm-weiße LED-Beleuchtung / Warm-white LED lighting
- Betriebsspannung für Analog- und Digitalbetrieb bis 22 V geeignet / Operating voltage suitable for analogue and digital operation up to 22 V
- Stromaufnahme bei ungekürzter Länge max. 25 mA / Power consumption with uncut length max. 25 mA
- Hinweis: Dieser Bausatz ersetzt alle bislang von TILLIG angebotenen Innenbeleuchtungs-Bausätze / Please note: This construction kit replaces all the interior lighting construction kits offered by TILLIG up to now

Nachrüstset Kontaktstreifen  
für Innenbeleuchtung  
Add-on-kit for interior lighting

Art.-Nr: 08869  
UVP in €: 3,70

- Zusatzteile zum Nachrüsten unserer neuen Innenbeleuchtung Art. 08858 für Doppelstockeinzelnwagen, Mod-Wagen, Halberstädter Mitteleinstiegswagen, Y- und Reko-Wagen (BTTB-Bauart) / Additional parts for the retrofitting of our new interior lighting art. 08858 for double deck single carriages, Modernisation carriages, Halberstädter centre entry carriages, Y and reconstructed carriages (Berliner TT Bahnen company – BTTB- models)



Innenbeleuchtung Aussichtswagen  
Interior lighting for passenger coach dom car

NEU / NEW Art.-Nr: 08854 UVP in €: 25,50

Dachstromabnehmer / Pantograph



Dachstromabnehmer für BR 189 (Wechselstromausführung Deutschland), passend auch für BR 101 und ICE  
Pantograph (German AC type) for class 101, class 189 and ICE

Art.-Nr. 08887 UVP in €: 15,90

Dachstromabnehmer für BR 189 (Wechselstromausführung Schweiz), passend auch für ICE schweizer Ausführung  
Pantograph (Swiss AC type) for class 189 and ICE swiss and ICE

Art.-Nr. 08888 UVP in €: 15,90



1 Paar Scheren-Dachstromabnehmer, rot, Einsatz für E 94/44, BR 250  
Pair of double-arm pantograph (red) for E 94/44, BR 250

Art.-Nr. 08885 UVP in €: 20,50

1 Paar Einholm-Dachstromabnehmer, rot, Einsatz für BR 243, BR 143/112  
Pair of single-arm pantograph (red) for class 243, class 143/112

Art.-Nr. 08886 UVP in €: 20,50

Gleisplan-CD / Track planning CD



CD-ROM 30 TT-Gleispläne von 1,60 – 3,00 m Länge (Standardgleis, Modellgleis, Bettungsgleis, inkl. Wintrack-Viewer), in Koop. mit Firma modellplan  
CD with track planning software, in cooperation with firm modellplan

Art.-Nr. 09548 UVP in €: 19,90

CD-ROM 25 TT-Gleispläne von 3,00 – 5,00 m Länge (Standardgleis, Modellgleis, Bettungsgleis, inkl. Wintrack-Viewer), in Koop. mit Firma modellplan  
CD with track planning software, in cooperation with firm modellplan

Art.-Nr. 09549 UVP in €: 19,90



Modellumrüstset für Standardgleis-Weichenantrieb, er enthält alle Bauteile, um die Weichenantriebe getrennt von den Weichen oberflur oder unterflur anzubringen.  
Kit for mounting model conversion set for standard track point drive, it contains all the component parts for the attachment of point drives separated by the surface mounted and underfloor mounted points.

Art.-Nr. 07960 UVP in €: 6,00



Art.-Nr. 08814 A UVP in €: 5,30

Elektrische Zugschlussbeleuchtung (für 4-achs. Rekowagen BTTB-Bauart)  
Electrical rear light

Art.-Nr. 08815 A UVP in €: 5,30

Elektrische Zugschlussbeleuchtung (für 4-achs. Y-Wagen BTTB-Bauart)  
Electrical rear light

**TIPP:** Planungs-Software „WINTRACK“  
Erhältlich im Fachhandel oder direkt von modellplan:  
Can be obtained from specialist dealers or directly from modellplan:  
ReuBensteinweg 4, 73037 Göppingen, Germany, www.modellplan.de

Literatur / Literature



Anleitungsheft „Ins richtige Gleis mit der TT-Bahn“, in Koop. mit dem Bradler-Verlag  
Tutorial book „Into the right track with the TT-Railway“, in coop. with Bradler-Verlag

Art.-Nr. 09571 UVP in €: 9,90



Anleitungsheft mit Vorlagen für Gleispläne  
Verlag G. Feuereißer  
Tutorial book for track planning, publisher G. Feuereißer

Art.-Nr. 09602 UVP in €: 8,95

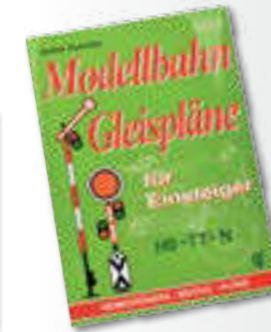

Anleitungsheft „Gleispläne für Einsteiger“  
Verlag G. Feuereißer  
Tutorial book for beginners, publisher G. Feuereißer

Art.-Nr. 09601 UVP in €: 5,00



Anleitungsheft „Elektrik für Einsteiger“  
Verlag G. Feuereißer  
Tutorial book „Electric for beginners“, publisher G. Feuereißer

Art.-Nr. 09603 UVP in €: 7,00

TILLIG-Straßenbahngleis / TILLIG-Tram track systemz

Freunde der Straßenbahn werden begeistert sein vom genial einfachen Prinzip unseres TILLIG-Straßenbahngleises und -Bodenflächensystems. Mit diesem ist es möglich, Modell-Straßenbahnen in Modellbahnanlagen problemlos zu integrieren. Wir bieten es in den Größen Spur H0 (Spurweite 16,5 mm) und Spur H0m/TT (Spurweite 12 mm) an.

Friends of trams will be brim over with enthusiasm for brilliant and easy principle of the TILLIG-Tram track and -ground area system. It is trouble-free possible to integrate model trams in model train layouts. We offer this system in gauge H0 (16,5 mm) and also in gauge H0m/TT (12 mm).

Das TILLIG-Straßenbahngleis ist auch zum vorbildgetreuen Nachbau von Industrieanschlüssen hervorragend geeignet. With this tram track system it is possible to create interesting industrial areas to be found in real-life installations.

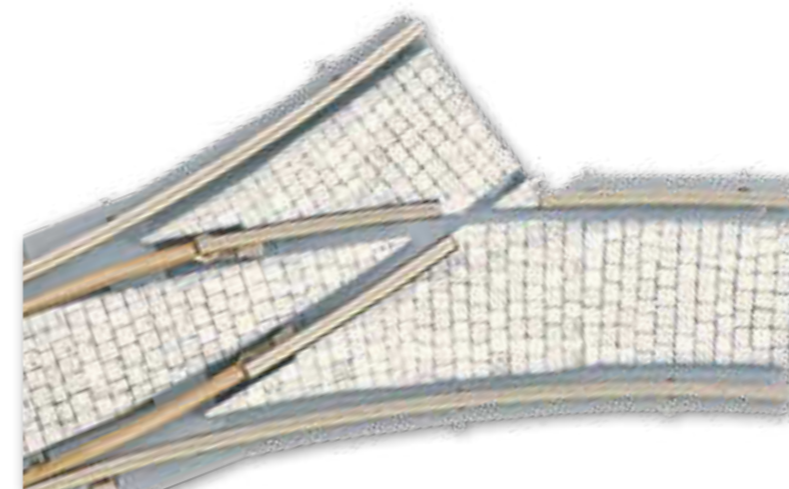
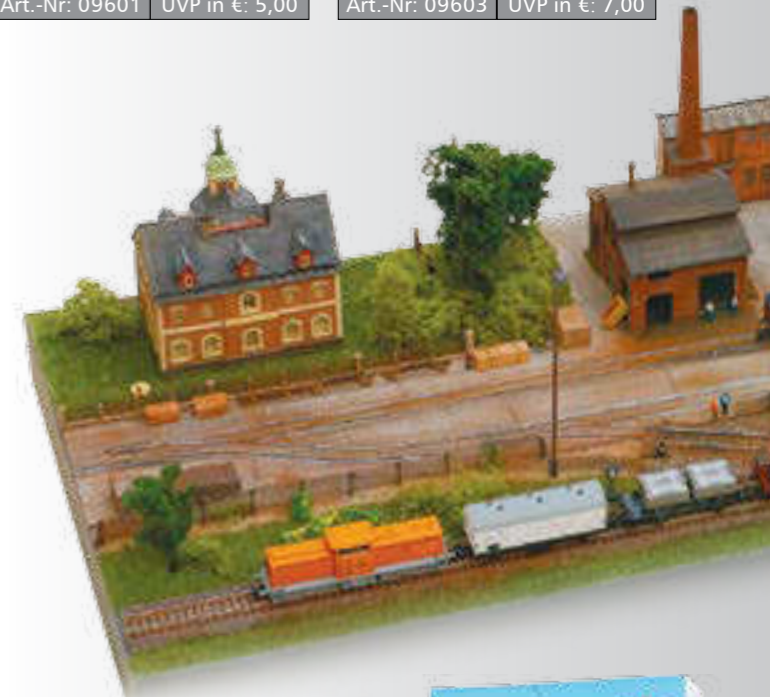

Weitere Informationen erhalten Sie unter: [www.tillig.com](http://www.tillig.com) und in unserem TILLIG-Gleis-Katalog

Further information you find under: [www.tillig.com](http://www.tillig.com) and in our special TILLIG catalogue for tracks

Art.-Nr. 09588 UVP in €: 2,50

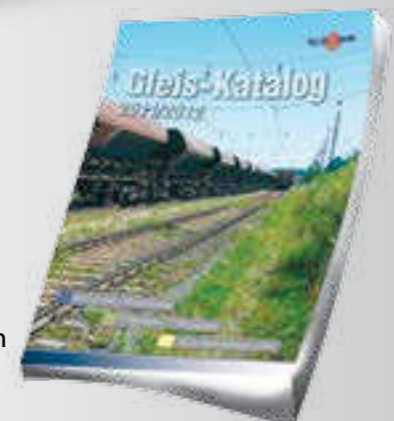







Güterwagen / Freight cars

Bezeichnung	Seite	Bezeichnung	Seite	Bezeichnung	Seite
					
<b>Kesselwagen, 4-achsig</b>		<b>Staubbehälterwagen, 4-achsig</b>		<b>Autotransportwagen</b>	
DR, Ep. IV	15431 68	DR, Ep. IV	15488 66	DR, Set, Ep. IV	01636 62
GATX, Ep. VI	15469 127	DB AG, Ep. V	15496 117	DR, Ep. IV	15050 62
ERMEWA, Ep. VI	15473 128	GATX, Ep. VI	15490 128	DR, Set, Ep. IV	01669 92
ČD Cargo, Ep. VI	15471 150	ERMEWA, Ep. VI	15492 128	DB, Set, Ep. IV	01638 111
CFR MARFA, Ep. VI	15468 164	ČD, Ep. VI	15494 150	DB AG, Set, Ep. V	01639 110
GYSEV, Ep. V	15475 164	SBB, Ep. VI	15489 168	DB AG, Set, Ep. V	01640 110
GYSEV, Ep. VI	15467 164	VTG, Ep. VI	15491 159	DB AG, Ep. V	15051 111
MILLET, Ep. VI	15474 170			ČD, Set, Ep. V	01641 148
RENFE, Ep. V	15432 170			ČD, Set, Ep. VI	01670 149
		<b>Schiebewandwagen</b>		ZSSK, Set, Ep. V	01668 152
<b>Staubsilowagen, 2-achsig</b>		DB, Ep. IV	15834 93		
DR, Set, Ep. III	01607 44	DB AG, Ep. VI	15833 117		
DR, Set, Ep. IV	01680 69	DB AG, Ep. VI	15832 117	<b>Sonst. Güterwagen, 2-achsig</b>	
DR, Ep. IV	17700 69	VR, „Jit-Trans“, Ep. VI	15835 126	DRG, Säuretopf, Ep. II	14446 24
DB, Ep. III	17731 82	ČD Cargo, Ep. VI	15804 150	DR, Klappdeckel, Ep. III	14712 41
DB, Ep. IV	17732 91	MAV, Ep. VI	15803 162	DR, Set Kalkkübel, Ep. III	01634 45
DB, Ep. IV	17730 91	SBB, Ep. V	15802 166	DR, Säuretopf, Ep. IV	14447 65
DB, Set, Ep. IV	01608 92	SJ, Ep. IV	15805 173		
DB, Ep. IV	17761 92				
DB AG, „VTG“, Set, Ep. V	01635 118				
DB AG, Ep. V	17701 118	<b>Schiebeplanenwagen</b>			
MEG, Set, Ep. VI	01609 129	DB Schenker, Ep. VI	15743 116		
ÖBB, Ep. IV	17733 156	AAE, „ENVILOC“, Ep. VI	15746 126		
SNCF, Set, Ep. IV	01681 169	ČD Cargo, Ep. VI	15745 150		
		EuroLuxCargo, Ep. V/VI	15747 170		

Art.-Nr.	Seite	Art.-Nr.	Seite	Art.-Nr.	Seite	Art.-Nr.	Seite	Art.-Nr.	Seite
01207	188	01651	73	02146	46	04613	144	08401	223
01208	188	01652	82	02160	27	04614	139	08410	223
01353	99	01657	106	02165	16	04621	135	08414	226
01357	137	01658	54	02178	84	04623	30	08415	226
01424	178	01659	145	02179	27	04625	151	08419	227
01425	182	01660	54	02180	135	04627	139	08430	227
01426	183	01661	55	02190	26	04628	152	08608	184
01428	178	01662	56	02191	18	04632	153	08609	184
01429	181	01664	83	02285	153	04635	135	08631	184
01431	179	01666	167	02286	46	04801	86	08632	184
01432	179	01667	55	02287	26	04900	98	08633	184
01434	180	01668	152	02292	26	04901	122	08634	184
01570	57	01669	92	02295	84	04903	122	08636	185
01576	58	01670	149	02299	134	04904	122	08678	184
01579	22	01671	64	02314	96	04906	171	08689	184
01595	74	01673	23	02337	50	04907	166	08691	184
01596	154	01674	129	02375	50	04908	161	08692	184
01599	125	01675	41	02390	98	04909	99	08711	185
01600	38	01677	113	02391	98	04910	123	08712	185
01606	143	01678	112	02394	71	04911	123	08730	184
01607	44	01679	126	02395	98	04912	123	08734	184
01608	92	01680	69	02450	50	04915	123	08736	184
01609	128	01681	169	02451	86	04930	120	08737	184
01610	51	01682	16	02452	154	04932	120	08738	184
01611	100	01683	39	02453	19	04933	120	08739	184
01612	101	01684	40	02454	31	04934	120	08792	185
01614	72	01686	107	02455	86	04940	96	08793	185
01616	75	01688	163	02477	121	04951	124	08794	185
01617	21	01833	176	02478	121	04952	157	08795	184
01620	35	01834	177	02500	85	04953	132	08796	185
01623	79	01835	177	02501	71	04954	159	08797	185
01625	161	01836	177	02503	85	04956	159	08798	184
01626	113	01837	177	02582	30	04962	145	08814	230
01627	43	02004	25	02672	31	07130	229	08815	230
01628	139	02020	25	02709	175	07160	229	08818	228
01629	131	02021	84	02712	85	07161	229	08819	228
01630	95	02022	16	02741	85	07170	229	08820	228
01631	65	02023	18	02780	47	07708	185	08823	225
01634	45	02024	134	02791	96	07745	185	08824	225
01635	118	02025	45	02850	31	07745	185	08827	225
01636	62	02050	45	02885	119	07910	227	08828	225
01638	111	02094	18	03010	27	07911	227	08840	225
01639	110	02095	129	03011	47	07920	227	08841	225
01640	110	02096	46	04531	171	07950	202	08842	225
01641	148	02101	18	04535	160	07960	230	08843	225
01642	43	02130	46	04536	121	08122	223	08845	225
01643	63	02131	71	04588	96	08131	222	08846	225
01644	83	02133	84	04589	47	08132	223	08847	225
01645	137	02135	25	04598	174	08211	223	08848	225
01646	130	02145	25	04611	135	08331	197	08849	225



Foto: TILLIG-Wechsarchiv



Art.-Nr.	Seite	Art.-Nr.	Seite	Art.-Nr.	Seite	Art.-Nr.	Seite	Art.-Nr.	Seite	Art.-Nr.	Seite	Art.-Nr.	Seite	Art.-Nr.	Seite	Art.-Nr.	Seite	Art.-Nr.	Seite
08854	229	13017	155	13626	175	14400	118	15280	134	15833	117	16697	140	17300	156	83101	202	83411	210
08858	229	13018	136	13697	87	14446	24	15281	115	15834	93	16700	152	17301	139	83102	202	83416	211
08869	229	13149	17	13698	125	14447	65	15298	148	15835	126	16701	141	17302	23	83103	202	83417	211
08870	228	13161	75	13731	141	14479	91	15300	162	16001	77	16702	153	17400	172	83104	202	83420	210
08871	228	13208	19	13732	131	14574	65	15321	138	16301	37	16703	153	17700	69	83105	202	83421	210
08872	225	13228	174	13738	103	14575	158	15322	44	16341	38	16704	151	17701	118	83106	203	83426	211
08874	228	13239	174	13739	132	14577	149	15350	66	16500	88	16720	59	17730	91	83107	203	83427	211
08875	228	13301	31	13748	132	14578	173	15351	115	16501	108	16721	160	17731	82	83109	203	83430	210
08876	228	13311	35	13759	175	14579	81	15352	115	16502	109	16722	131	17732	91	83110	203	83431	210
08877	228	13321	35	13779	100	14579	168	15370	66	16503	89	16723	141	17733	156	83111	203	83436	211
08878	228	13411	19	13780	101	14585	94	15371	115	16504	106	16724	103	17761	92	83112	203	83437	211
08879	228	13412	34	13800	104	14586	81	15431	68	16505	108	16725	144	18001	117	83113	203	83440	210
08880	228	13417	155	13802	104	14587	65	15432	170	16520	147	16726	162	18002	157	83114	203	83441	202
08881	228	13426	62	13803	104	14588	114	15468	164	16530	147	16727	133	18100	172	83115	203	83442	202
08882	228	13455	17	13807	167	14628	17	15469	127	16531	158	16728	148	18101	67	83116	203	83495	211
08883	228	13475	155	13821	35	14649	175	15471	150	16532	148	16729	152	18102	68	83120	202	83500	210
08884	228	13476	77	13827	20	14658	24	15471	170	16533	107	16750	60	18103	159	83125	204	83502	210
08885	230	13518	78	13830	79	14690	67	15473	128	16534	145	16900	36	18104	169	83132	202	83517	214
08886	230	13519	78	13842	105	14691	94	15475	164	16580	89	16901	87	18105	162	83134	204	83531	213
08887	230	13522	102	13850	79	14692	164	15488	66	16590	89	16920	36	18150	166	83136	204	83532	213
08888	230	13523	102	13851	79	14693	149	15489	168	16600	45	16921	87	18151	93	83139	202	83533	213
08890	228	13524	102	13856	90	14694	67	15490	128	16601	103	16922	74	19001	185	83143	209	83534	213
08912	209	13525	102	13857	90	14695	142	15491	159	16620	103	16923	20	19002	185	83149	209	83560	229
08913	209	13526	90	13860	105	14712	41	15492	128	16621	51	16940	36	19020	185	83150	209	83561	229
08914	189	13530	88	13861	105	14758	158	15494	150	16640	141	16941	87	66012	191	83151	209	83571	229
08931	227	13532	167	13863	90	14759	142	15496	117	16641	160	16960	37	66013	191	83154	209	83700	197
08940	227	13535	157	13864	105	14822	80	15497	164	16642	131	16970	37	66014	191	83155	209	83701	194
08960	184	13536	133	13887	36	14920	42	15568	93	16643	140	16971	86	66016	191	83156	209	83702	194
08960	227	13537	171	13888	54	14922	138	15569	116	16644	59	16972	136	66017	191	83158	209	83703	194
08961	227	13538	168	13891	20	14923	81	15571	143	16645	146	16975	74	66020	189	83159	209	83704	194
08970	227	13539	165	13892	136	14970	118	15575	116	16646	146	17132	42	66021	189	83161	208	83705	194
08972	227	13550	157	13894	77	14971	127	15581	68	16647	140	17133	138	66022	189	83170	208	83706	194
08973	227	13551	167	13896	37	14995	127	15582	162	16648	59	17134	81	66023	189	83201	209	83707	194
08974	227	13552	168	14017	80	14996	91	15584	68	16649	59	17150	80	66050	191	83210	208	83709	194
08976	197	13553	133	14108	44	14998	173	15585	173	16650	61	17151	142	66051	191	83230	207	83710	194
08976	227	13554	171	14109	172	14999	127	15586	116	16651	140	17152	161	66120	189	83300	208	83711	197
08977	227	13555	158	14117	175	15050	62	15587	165	16652	61	17153	67	66588	189	83321	206	83712	194
09548	230	13556	165	14124	24	15051	111	15610	93	16653	144	17154	111	83001	210	83322	206	83713	194
09549	230	13558	157	14125	41	15241	95	15612	24	16656	144	17155	80	83003	210	83326	211	83714	194
09571	231	13564	108	14126	24	15246	66	15614	129	16657	146	17156	80	83006	210	83327	211	83715	194
09588	231	13571	109	14127	165	15247	114	15616	43	16658	151	17158	111	83007	210	83331	206	83716	194
09601	231	13572	88	14148	175	15248	158	15743	116	16659	151	17159	143	83008	210	83332	206	83717	194
09602	231	13576	109	14266	142	15250	143	15745	150	16660	60	17160	132	83009	210	83341	206	83718	194
09603	231	13579	88	14269	175	15252	149	15746	126	16661	61	17242	62	83011	210	83342	206	83719	194
13001	34	13581	109	14276	138	15253	134	15747	170	16662	133	17243	95	83012	210	83361	206	83720	194
13004	155	13582	124	14277	129	15254	114	15802	166	16663	146	17244	131	83016	210	83362	206	83721	196
13008	19	13592	161	14278	156	15255	165	15803	162	16664	147	17245	81	83025	210	83380	207	83722	196
13008	155	13593	60	14282	23	15256	160	15804	150	16665	160	17246	95	83034	210	83382	207	83723	196
13009	136	13609	175	14283	41	15257	163	15805	173	16695	147	17247	168	83036	210	83391	208	83724	196
13010	34	13625	175	14284	17	15258	169	15832	117	16696	60	17248	170	83100	202	83410	210	83725	196

83711	.....	197	83862	.....	195	86324	.....	219	86422	.....	219
83712	.....	194	83863	.....	195	86326	.....	219	92653	.....	25
83713	.....	194	83864	.....	195	86331	.....	218	95211	.....	139
83714	.....	194	83950	.....	197	86332	.....	218	95212	.....	129
83715	.....	194	83951	.....	197	86341	.....	218	95213	.....	156
83716	.....	194	83952	.....	197	86342	.....	218	95214	.....	143
83717	.....	194	83953	.....	197	86351	.....	217	95291	.....	42
83718	.....	194	83954	.....	197	86352	.....	217	95828	.....	24
83719	.....	194	83955	.....	197	86353	.....	217	95830	.....	82
83720	.....	194	83960	.....	197	86354	.....	217	95831	.....	156
83721	.....	196	83961	.....	197	86355	.....	217	95832	.....	24
83722	.....	196	83963	.....	197	86356	.....	217	95833	.....	44
83723	.....	196	85500	.....	211	86358	.....	217	95834	.....	130
83724	.....	196	85501	.....	211	86360	.....	217	95835	.....	23
83725	.....	196	85502	.....	210	86361	.....	218	95836	.....	44
83726	.....	196	85506	.....	210	86362	.....	218	95837	.....	172
83727	.....	196	86101	.....	210	86365	.....	218	96112	.....	30
83728	.....	196	86102	.....	210	86366	.....	218	96114	.....	119
83729	.....	196	86112	.....	213	86369	.....	219	96151	.....	47
83730	.....	196	86301	.....	217	86370	.....	219	210190	.....	225
83731	.....	196	86302	.....	217	86371	.....	219	396942	.....	197
83732	.....	196	86303	.....	217	86372	.....	219	396943	.....	197
83740	.....	197	86304	.....	217	86374	.....	219	501067	.....	50
83741	.....	197	86305	.....	217	86376	.....	219	501137	.....	185
83758	.....	197	86306	.....	217	86381	.....	218	501285	.....	23
83759	.....	197	86308	.....	217	86382	.....	218	501273	.....	42
83760	.....	195	86310	.....	217	86391	.....	218	501279	.....	107
83761	.....	195	86311	.....	218	86392	.....	218	501286	.....	70
83801	.....	197	86312	.....	218	86401	.....	219	501287	.....	56
83802	.....	197	86315	.....	218	86406	.....	219	501323	.....	166
83816	.....	195	86316	.....	218	86407	.....	219	501324	.....	69
83817	.....	195	86319	.....	219	86411	.....	219			
83820	.....	195	86320	.....	219	86412	.....	219			
83821	.....	195	86321	.....	219	86413	.....	221			
83861	.....	195	86322	.....	219	86421	.....	219			

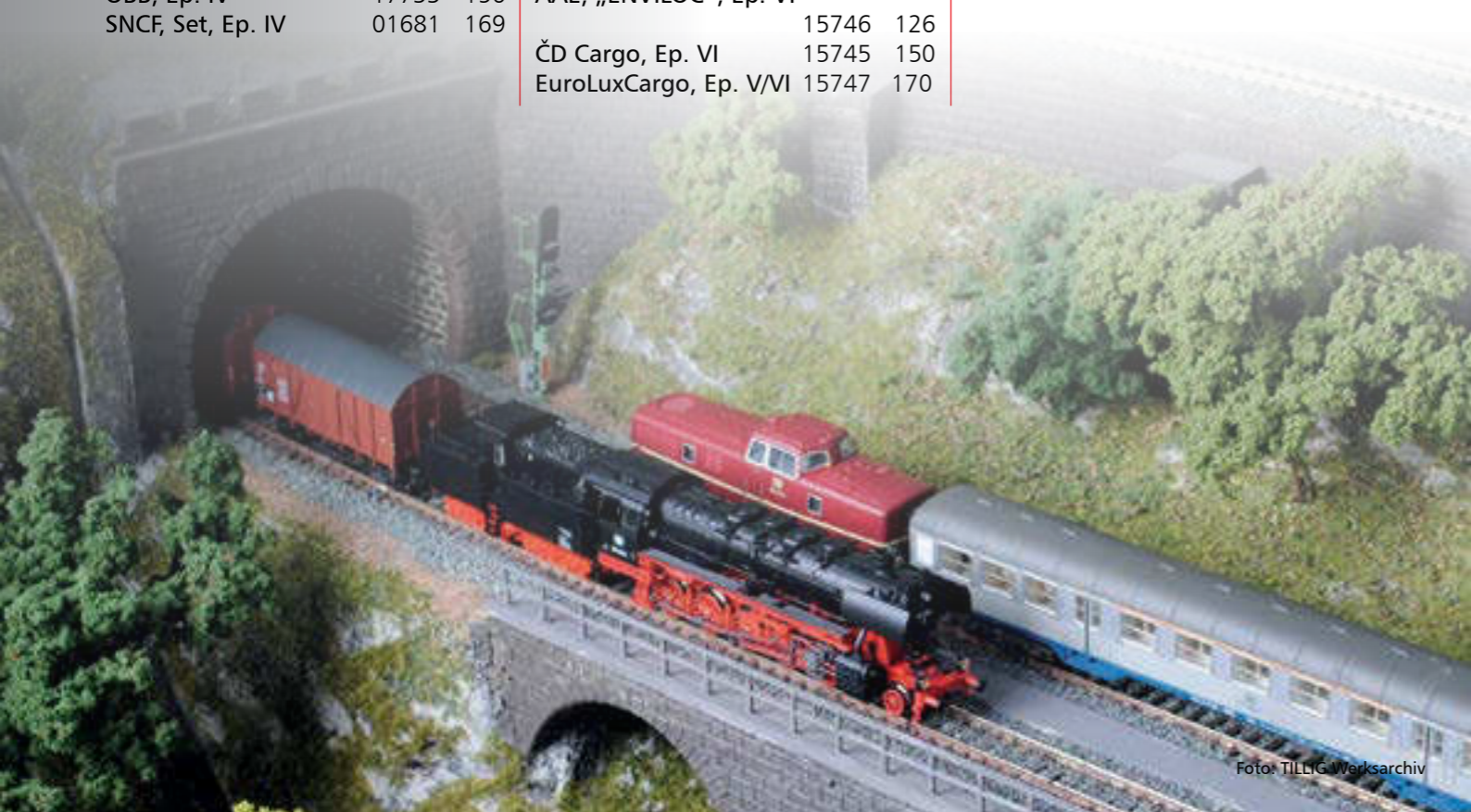

Foto: TT-Club Dänemark

## Impressum:

Herausgeber:  
TILLIG Modellbahnen GmbH  
Promenade 1, 01855 Sebnitz  
info@tillig.com, www.tillig.com

Gestaltung, Texte und Druckvorstufe:  
TILLIG Modellbahnen GmbH,  
Werbeabteilung

Titelfoto: Dampflokomotive BR 38.10  
der DR, Ep. III (Art.-Nr. 02020),  
Rheingold-Set 1 der DB, Ep. III  
(Art.-Nr. 01614),  
TILLIG Werbeabteilung

Fotos:  
Rainer Albrecht, Seefeldt-Remschütz;  
Ulrich Gnauck, Neustadt/Sehlsen;  
Werkarchiv TILLIG, Sebnitz; Weitere Fotos  
siehe Namensangaben an den Abbildungen.

Druck und Weiterverarbeitung:  
Fahner Druck GmbH  
Hans-Bunte-Straße 43, 90431 Nürnberg

Alle Rechte vorbehalten. Änderungen und geänderte Liefermöglichkeiten sind ohne Ankündigung vorbehalten. Spezifikationen, Maße, Preisangaben und Abbildungen ohne Gewähr. Für Schreibfehler, Irrtümer oder Verwechslungen übernehmen wir keine Haftung. Nachdruck und jede Art der Vervielfältigung, auch auszugsweise, bedarf der vorherigen schriftlichen Genehmigung der Firma TILLIG Modellbahnen GmbH. TILLIG-Produkte werden ausschließlich über den Fachhandel angeboten.

\*Preisangaben: Unverbindlich empfohlener Verkaufspreis für Deutschland.

Gedruckt in Deutschland, 2014



Foto: TILLIG Werkarchiv



Ihr Fachhändler

TILLIG Modellbahnen GmbH  
Promenade 1, 01855 Sebnitz  
Tel.: +49 (0)35971 903-0  
E-Mail: [info@tillig.com](mailto:info@tillig.com)  
[www.tillig.com](http://www.tillig.com)

